



## OPERATOR'S GUIDE

TruFade Artificial Light  
Fastness & Weathering Tester

Model Number 1800

Covering Serial Numbers  
1800/18/1001 & upwards

Published by:

JAMES HEAL  
RICHMOND WORKS  
HALIFAX  
WEST YORKSHIRE  
HX3 6EP  
ENGLAND

TELEPHONE +44 (0) 1422 366355

FACSIMILE +44 (0) 1422 352440

E-mail [info@james-heal.co.uk](mailto:info@james-heal.co.uk)

Internet <http://www.james-heal.co.uk>

© 2021

# TABLE OF CONTENTS

OPERATOR'S GUIDE .....	1
Table of Contents.....	3
JAMES HEAL .....	5
Setting the Standard.....	5
Areas of Expertise .....	5
Trufade – Artificial Light fastness & Weathering Tester .....	6
Standards .....	7
Safety .....	8
General .....	8
Quick Start - Trufade TestWise Touch .....	9
Trufade TestWise Touch – Exploring Other Options .....	13
Odometer Lamp & Filter Settings.....	18
Updating TruFade Software (Firmware).....	38
Routine Maintenance by User .....	39
<b>Air Filters</b> .....	39
<b>Test Chamber Air Exhaust</b> .....	39
<b>Optical Filters</b> .....	39
<b>Xenon Lamp</b> .....	39
<b>Water Supply</b> .....	39
<b>Test Chamber</b> .....	39
Mounting Specimens and Blue Wools.....	40
Guide using the Tri-Sided Sample Holder.....	40
Specimen Holders and Masks .....	42
ISO Specimen Masks .....	43
AATCC Specimen Masks .....	44
TruFade Glassware .....	45
Installing or Replacing the Xenon lamp.....	45
Fitting or Replacing an Optical Filter .....	45
UG11 Filter Placement for High Humidity Tests.....	45
Replacing Borosilicate Cylinder .....	46
Accessing the Glassware .....	47
The Xenon Lamp.....	52
Fitting the Xenon Lamp .....	53
General Principles of Light Fastness testing .....	54
Specimen Temperature .....	54
SolarSens and Black <i>Standard</i> Thermometer.....	54
Black <i>Panel</i> Thermometer (BPT).....	55
The Concept of Effective Humidity.....	56

Humidity Test Control Fabric .....	56
Obtaining 40% Effective Humidity.....	57
Determining Effective Humidity.....	57
Blue Wool Mode (Nominal Power Mode).....	58
Controlled Irradiance Mode .....	58
Weathering Blue Wool Sample Holder.....	60
Installation.....	61
Operating Environment.....	61
Installation Requirements .....	62
Electrical Connection.....	62
Heat Output.....	63
Water Supply and Drains.....	63
Water Consumption.....	66
ISO 3696 - Requirements for Grade 3 Water.....	66
Unpacking.....	67
Technical Specification .....	71
EU Declaration of Conformity .....	73
UKCA Declaration of Conformity .....	74
External Dimensions.....	75
Revision History .....	76

# JAMES HEAL

At James Heal, we are dedicated to designing and developing high precision testing instruments and test materials for physical and colour fastness testing. Our worldwide Service and Calibration division and expert technical assistance complement our product range, adding real value to your laboratory testing activities.

## Setting the Standard

We are committed to forming close relationships and have established numerous partnerships within the textile industry, from trade and standards organizations, to test houses, customers and distribution partners.

With a heritage spanning more than 140 years, we have evolved and grown through a culture of continuous improvement, resulting in a thorough understanding of the applications, operating conditions and requirements of customers worldwide – from independent testing laboratories and test houses, to fabric suppliers, manufacturers and retailers.

Using knowledge and expertise, we consistently set the industry standard through product innovation and technology, with customer and user needs, present and future, driving our technological advancements. You can be assured that with James Heal, you will always receive the highest levels of product quality and customer service. We have Agents and Distribution partners all over the globe, ensuring locally available product whenever, and wherever you need it.

## Areas of Expertise

### Textile: Colour Fastness

- Chlorinated Water
- Dry Cleaning
- Dry Heat
- Hot Pressing
- Laundering
- Light
- Perspiration
- Phenolic Yellowing
- Print Durability
- Rubbing
- Washing
- Water

### Textile: Physical

- Abrasion
- Bursting Strength
- Compression and Puncture
- Crease and Wrinkle Recovery
- Crimp
- Drape
- Durability
- Flammability
- Mass per unit area
- Pilling and Fuzzing
- Security of Attachments
- Seam Slippage
- Shrinkage
- Snagging
- Spray Rating
- Stretch and Recovery
- Surface Deterioration
- Tear Strength
- Tensile Strength
- Washing and Drying

### Non-Textile

- Bursting strength of nonwovens, plastics, paper and medical products
- Micro-scratching of laminates, wooden, painted, automotive and high gloss surfaces
- Physical and colour fastness testing of leather
- Rubbing fastness of laminates and wooden surfaces
- Tear strength of paper and plastics
- Rubber testing – tensile strength and abrasion resistance

# TRUFADE – ARTIFICIAL LIGHT FASTNESS & WEATHERING TESTER

TruFade 1800 is James Heals outstanding next generation Artificial Light Fastness & Weathering tester. Incorporating James Heals established Xenon arc lamp technology with a revolutionary Tri-Sided specimen holder. Compliant with textile and leather light fastness and weathering standards.

TruFade was the first James Heal instrument to use our latest touch screen control panel and wonderfully intuitive software. This instrument has been designed to combine the James Heal stylish product signature with user centred design for a superb user experience.

## Features

- Sleek, ergonomically designed Artificial Light fastness & Weathering Tester.
- Proven, high performance, air cooled Xenon Lamp Technology.
- Nominal Power and Irradiance controlled operating modes.
- SolarSens radiometer, incorporating Black Standard Thermometer (BST).
- Spacious design featuring easy loading and unloading of specimen holders.
- Up to 27 sample holder faces giving a total exposure area of 1640cm<sup>2</sup>.
- Complies with International Testing standards for textiles.
- Close control of chamber temperature and humidity.
- Easy editing of pre-programmed standards and creation of bespoke testing conditions.
- Simple and intuitive touch screen control panel.
- 'Three Clicks' to start testing !



## Service and Calibration

- Worldwide Service
- ISO 17025 based Calibration Service
- 18 Months' Warranty

## Technical Assistance

- Operator Training
- Knowledge transfer
- Applications Support
- Engineering Support

## STANDARDS

TruFade is pre-programmed with the following standards:

AATCC 16.3 – 2017 Option 3  
AATCC Test Method 169 – 2017 Option 4

ISO 105-B02: 2014 Cycle A1  
ISO 105 B02: 2014 Cycle A3  
ISO 105 B02: 2014 Cycle B  
ISO 105-B04: 1997  
ISO 12040: 1997 (2003)

GB/T 8427 – 2008

M&S C9 – 2015  
M&S C9A – 2015  
Next TM1  
Adidas 5.11 version 02  
Decathlon DS-288 version C

Should you wish to use TruFade for a standard or test method not specified above, or for a variation of the pre-defined parameters for any of the standards above, the user has the option to create or amend methods.

# SAFETY

## General

TruFade has been specifically designed with the Operator's health and safety in mind. All touch points are engineered to give an excellent and safe user experience.

To ensure your safety, please observe the following points at all times:

- Read and refer to this Operator's Guide carefully before operating the instrument
- Observe the installation requirements for correct instrument performance
- Items in the test chamber can become hot during a test – exercise caution when handling and use gloves where necessary
- Always allow the instrument to cool down sufficiently before handling the lamp and other glassware
- Never place flammable or explosive materials in the test chamber
- Never operate the TruFade without a full complement of optical filters, specimen holders and borosilicate cylinder
- Only use James Heal approved spare parts and consumables
- Have the TruFade serviced at least once a year by a James Heal Service and Calibration Engineer
- Following good health and safety practice, before removing or replacing the Lantern assembly, Optical Filters or Xenon Lamp, always isolate the electrical supply to avoid danger of electrical shock





# QUICK START - TRUFADE TESTWISE TOUCH

The TruFade TestWise Touch user interface has been designed with the user in mind.

The following section will guide you quickly through the simple steps of carrying out a Light Fastness test to either ISO 105-B02 or AATCC Method 16.3.



When the electrical power connected the TruFade will initialise and display the Test screen.

The Standard which was used last will be displayed.

To select a new Standard, tap the Standards button



Standards Groups

Standards



To select an AATCC standard, tap the AATCC button



Tap on the required Standard



Parameter values currently setup for the selected Standard

Tap the Accept button



For AATCC 16.3 Option 3, ensure the Black Panel Thermometer is placed in TruFade.

If the Start button is pressed at this point (Hours 00:00) then the test will run indefinitely until stopped.

Next, enter a Duration for the test  
Tap the Hours button

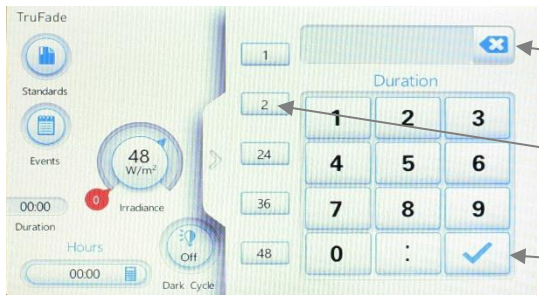

Backspace

"Radio Buttons" with preset Durations (hours).

Accept/Enter



Enter the test Duration required

To enter a Duration which includes minutes, enter the hours, then the colon key, then the minutes required

Tap the tick button to accept/enter



The test is now ready to Start

At this point, Test End displays only the set Duration

After the test is started, the Test End display will update with the estimated end day and time



Press the Start button



After a few seconds the display will update.

The Dials display the set and actual conditions.

The Test End day and time is now updated.



After 10 minutes ...

The Dials are now showing that the Irradiance and Relative Humidity are now correct.

However, the Black Panel Temperature is still increasing to the set point.



After 20 minutes ...

The Black Panel Temperature is still increasing.



After 30 minutes ...

The conditions in the Test Chamber have now stabilized.



Notice the progress of the test (elapsed time) is also indicated on the Pause Dial.

If the Rain or Dark Cycles are active, their progress will also be indicated.

To pause the test, tap the Pause button



The test stops and the Xenon Lamp is switched off.

To terminate the test, press and hold the Resume button.

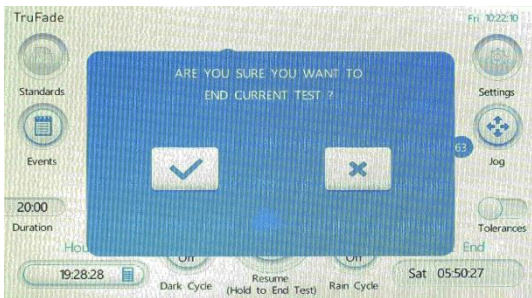

To continue the test then tap "x"

To terminate / end the test then tap "✓"



When the test Duration time has elapsed, the Test End will display "✓"

Congratulations - you have successfully started using **TruFade**

# TRUFADE TESTWISE TOUCH – EXPLORING OTHER OPTIONS

In the previous section we were given the express tour of TruFade TestWise Touch. This section explores other options.



When the electrical power connected the TruFade will initialise and display the Test screen.

The Standard which was used last will be displayed.

To select a new Standard, tap the Standards button.



The Standard which was used last will be displayed.



To changes to ISO 105-B04, tap the ISO group, then tap the required Standard in the list.



To change the parameter setting values for Relative Humidity, Temperature and Irradiance, tap the required Dial.

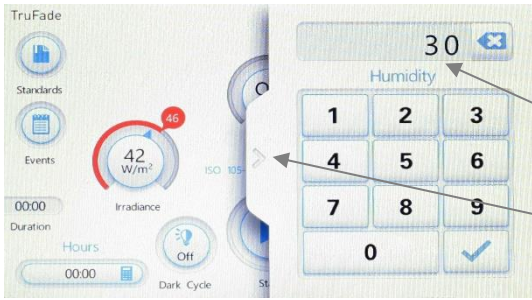

Use the numeric keyboard and tap the "✓" key to accept the new value.

To cancel, close the keyboard by tapping ">"

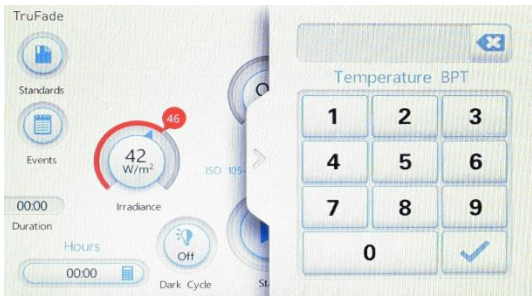

Etc ...

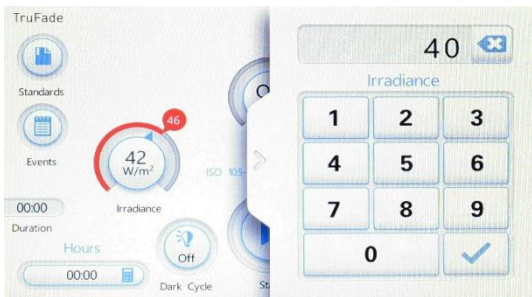

Etc ...

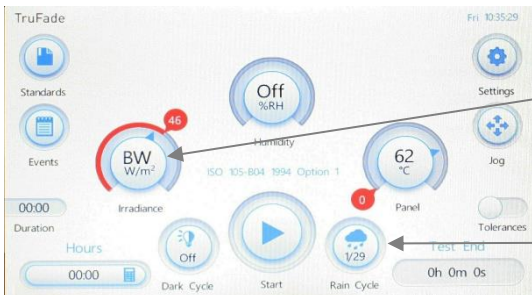

To change from Controlled Irradiance mode to Blue Wool mode (nominal power), press and hold the Irradiance Dial

To change the Rain Cycle time, tap the Rain Cycle button



Swipe up or down on the spinners (scroll wheels) to the required values.

## Changing the Duration Radio Buttons



There are five (5) Duration radio buttons which can be customized to suit user requirements.

For example, to change button #3 from 24 hours to 20 hours ...



Type 20 (or the time required) and then press and hold button #3.



After a few seconds the radio button will be updated.

## Viewing the Events Log

To view the Events log, tap the Events button

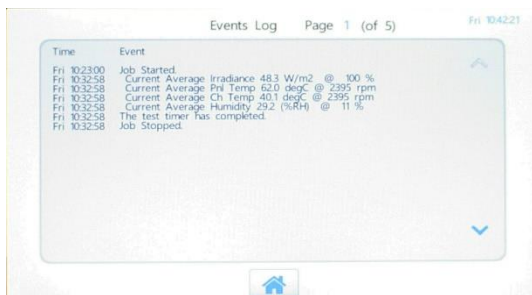

Test events are recorded here. These include when tests are started or stopped, and any system messages.

Up to 100 events can be viewed over five pages. The events will automatically overwrite so you can always review what's been going on when the machine has been left unattended.

## Settings



To access the Settings, tap the Settings button



The Settings General tab will be displayed.

The Calibration1 and Calibration2 tabs are not accessible to users, they are used by James Heal Engineers only.

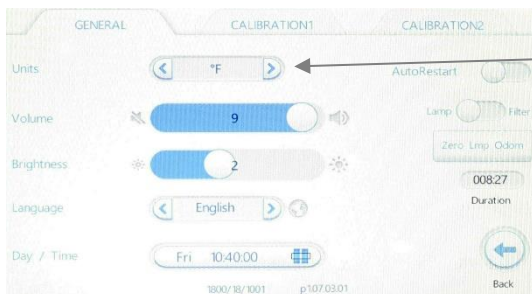

Change the Temperature units from °C to/from °F



Auto-Restart  
Automatically resumes the test should the power fail mid-test.

Increase or decrease the speaker Volume and display Brightness.





View and reset (zero) the Xenon Lamp and Filter timers.

Please note that the user must manually view the timers.

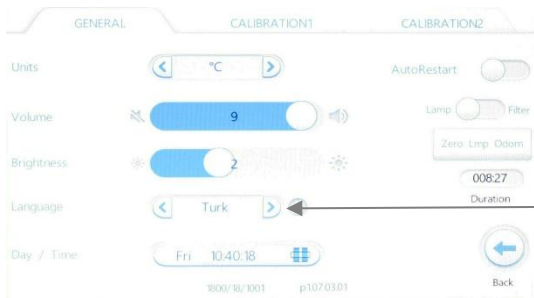

Change the Language used.

Languages available:  
 English, Chinese, French, German, Italian,  
 Japanese, Korean, Spanish, Turkish,  
 Vietnamese

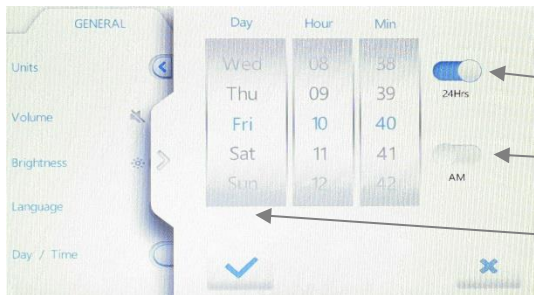

Set clock as 24 hours or 12 hours.

If 12 hour display selected, ensure correct AM or PM is selected.

Select the Day of the week.

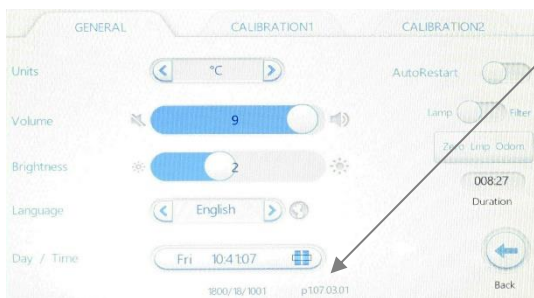

TruFade serial number and Firmware version

## Odometer Lamp & Filter Settings

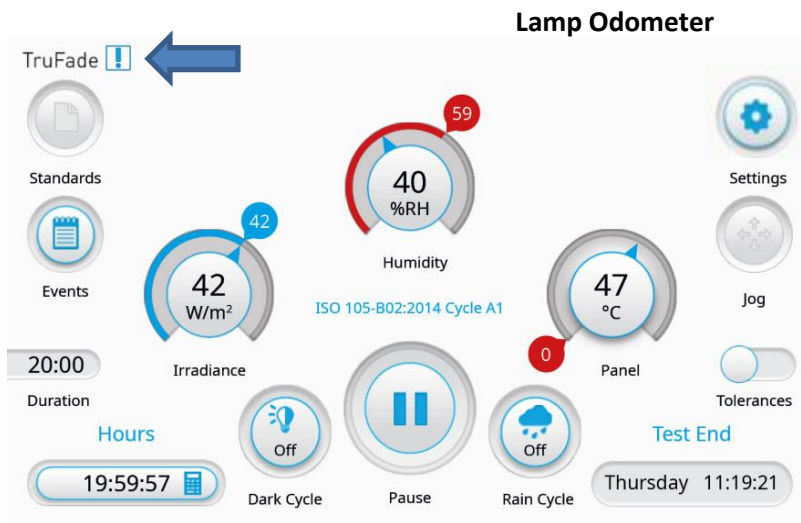

The Odometers have a warning alert when the set hours have been reached or will be reached during the duration of a test.

This is marked by an exclamation mark:



Access the GENERAL screen by selecting the 'Settings'. Tap on the radial button to select on the touch screen:



GENERAL Screen



When off the Odo Warning alert switch is toggled to the left.



To turn the alert on toggle the Odo Warning switch to the right.

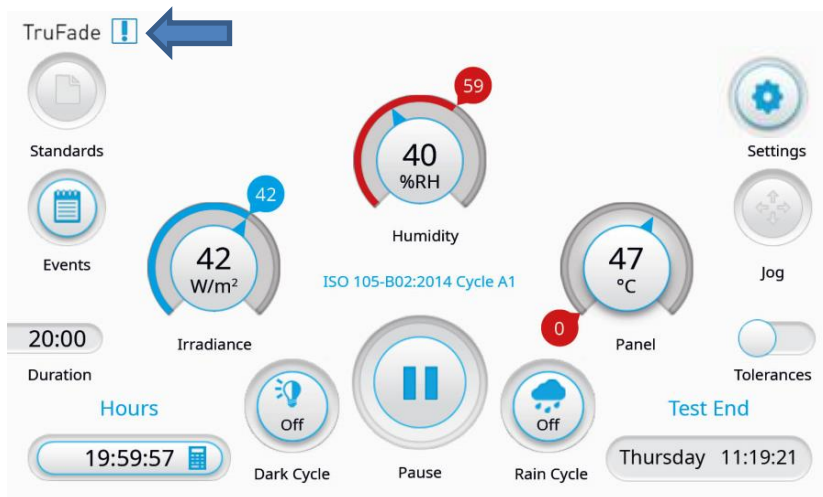

When the Odo Warning alert is switched to 'on' and once the lamp has exceeded its set lamp life, the exclamation

symbol: 

will show on the home screen until the lamp is changed or the warning switched off.

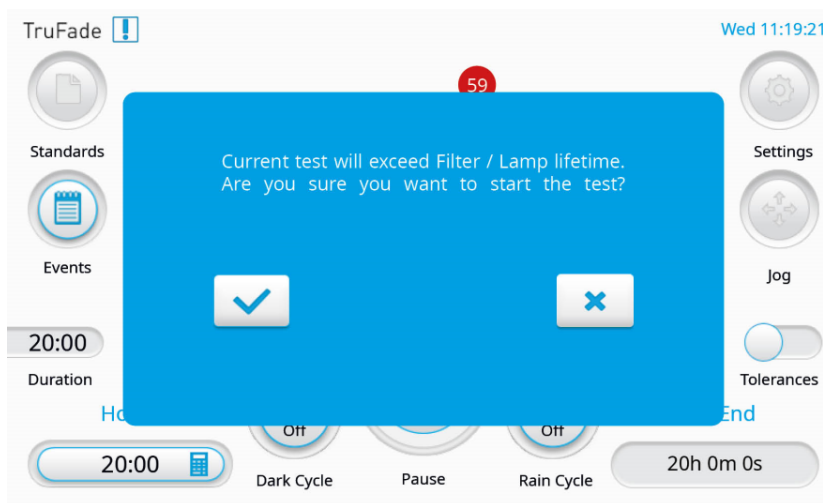

Also, when the max lamp life has been reached or will be reached during the next set test duration, the alert box will appear at the beginning of every new test/power up.

If the user wants to continue using the lamp after it has exceeded the set lamp life then select ✓ (Not advised).

If the lamp is to be changed for a new one, then select ✗ and conduct the following instructions:

### Changing & resetting the lamp odometer settings when changing the lamp:



To go to the Lamp & Filter Odometer (counter) menus, press the Lmp/Fit button.

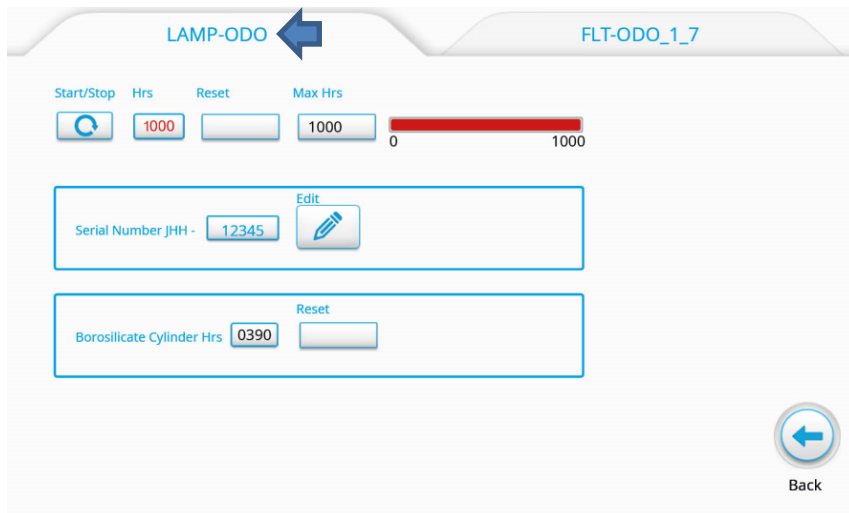

The LAMP ODO menu will appear (behind can be seen the tab for the Filter Odometer menu @FLT-ODO 1-7 – see later pages for instruction on this).

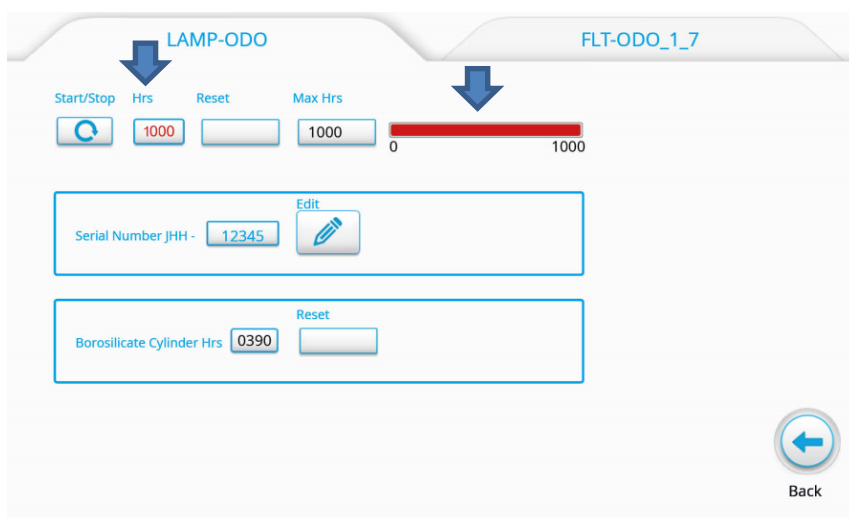

When the progress bar and the hours counter is red this indicates that the pre-set maximum number of lamp hours has been reached.

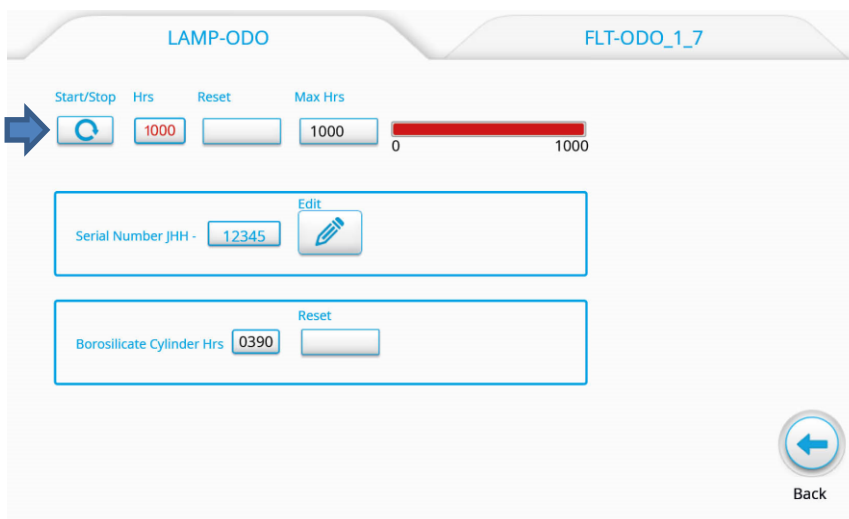

The odometer counter will show the circular play ring symbol on the Start/Stop button.

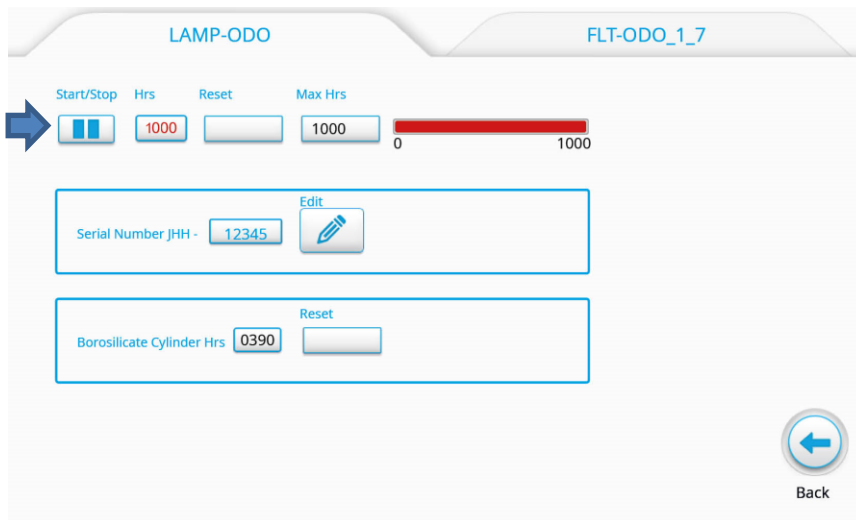

To stop the counter, press the start/stop button and the pause symbol will be displayed.

Use Stop when changing the lamp if it has reached its max hours or needs to be changed earlier than this for any reason.

*For instructions on how to change the lamp: See sections 'Accessing the glassware' & 'Changing the Xenon Lamp' sections in this document.*

### Changing the lamp serial number:

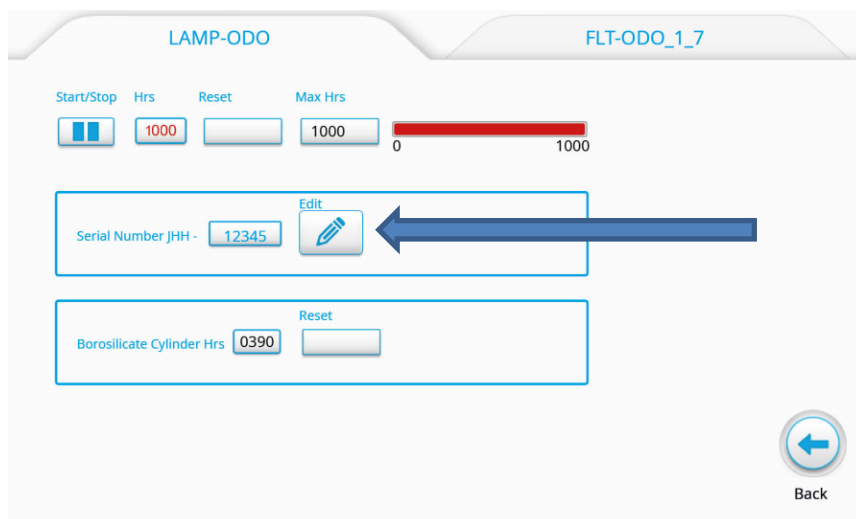

When replacing the lamp, the new serial number will need to be added.

Press the edit button

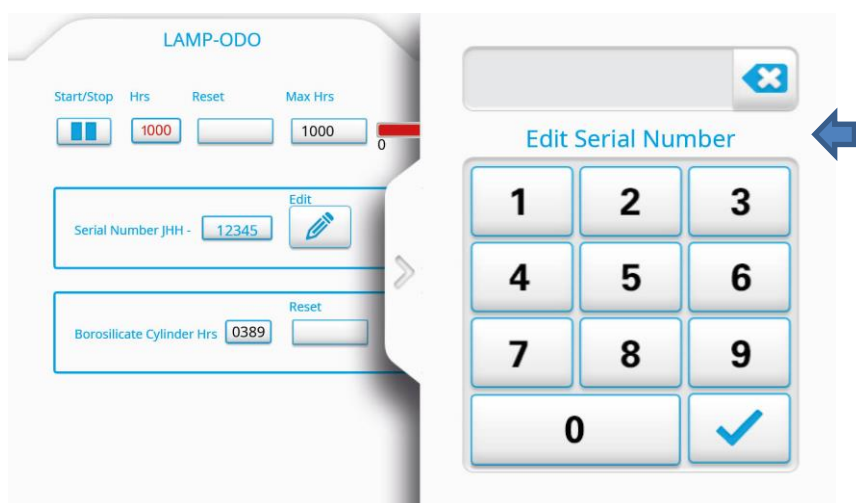

The 'Edit serial Number' keypad will appear



Using the keypad enter the lamp serial number

Once input select ✓ to enter and save.

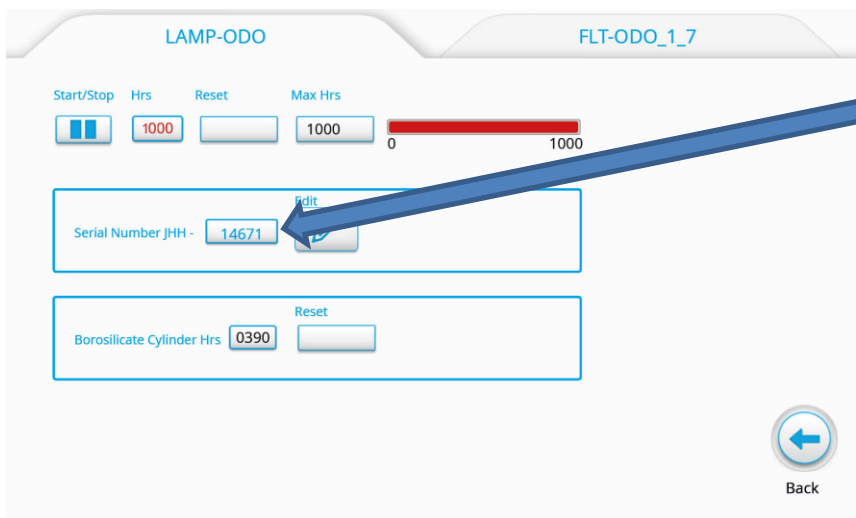

The new serial number is now set

When a new lamp is in place & new serial number is input, the lamp hour counter will need to be reset:

**Resetting the lamp hour counter:**

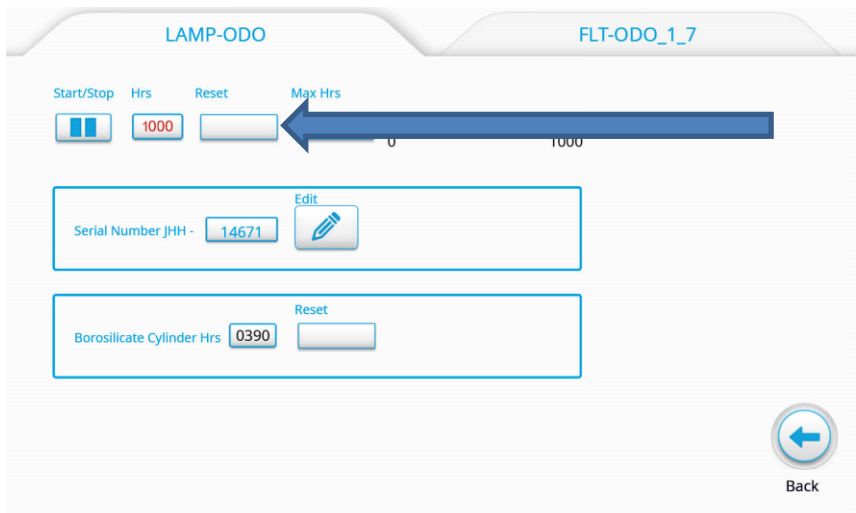

To reset the lamp hour counter press Reset

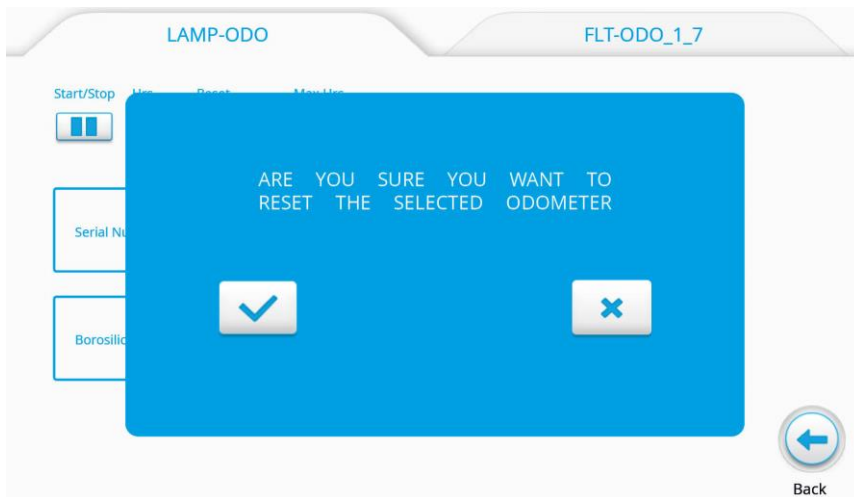

The change verification box will appear, select ✓

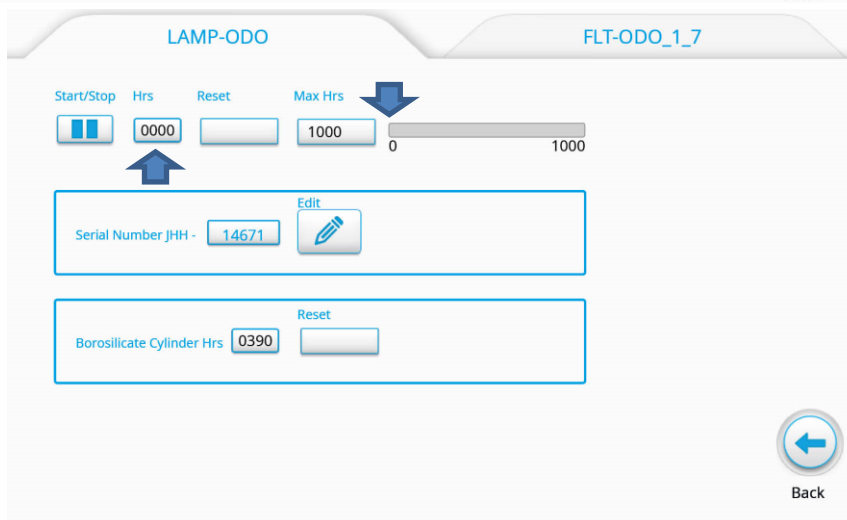

The lamp hour count is now reset to zero

### Changing the lamp 'Max Hours' setting:

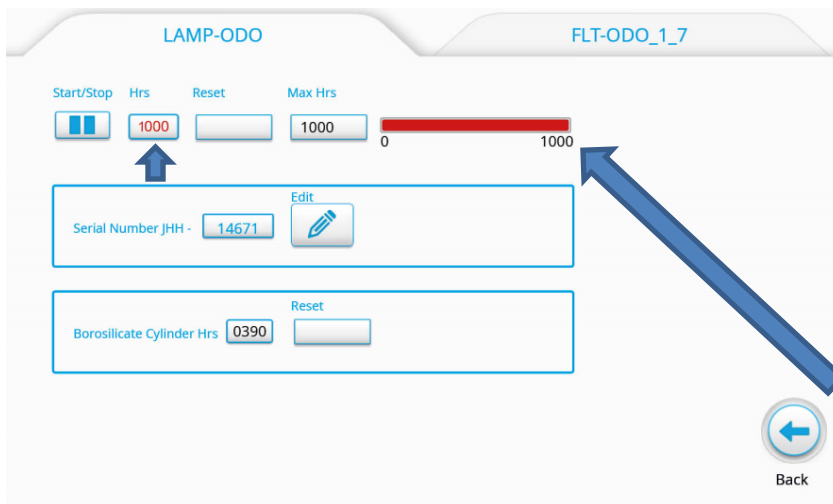

**The following should only be conducted when a new lamp with a different life span is placed in the machine or if the incorrect lamp life span was initially input.**

When the progress bar and the hours counter is red this indicates that the maximum number of lamp hours has been reached – the lamp needs changing at this point.

*For instruction on how to change the lamp, see sections 'Accessing the glassware' & 'Changing the Xenon Lamp' sections in this document.*

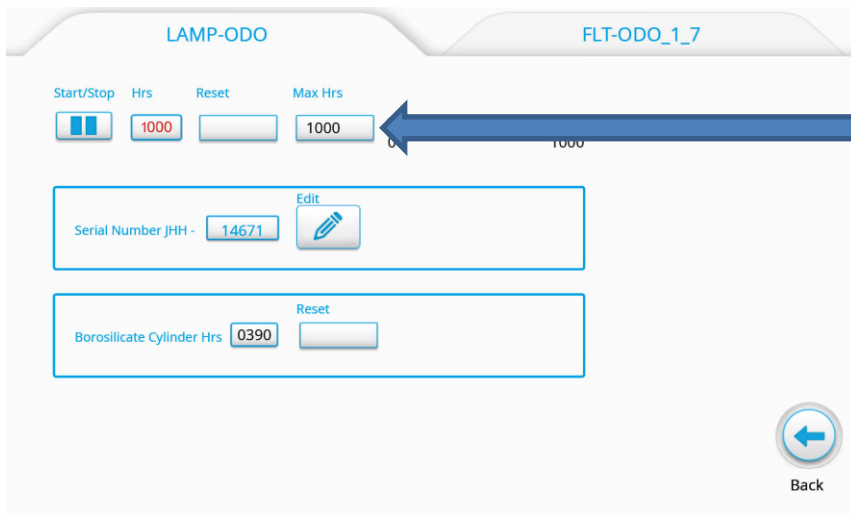

To change the maximum number of lamp hours required before inspection & change of the lamp.

Press the Max Hrs button



The 'Set Max Odo hrs' keypad will then appear

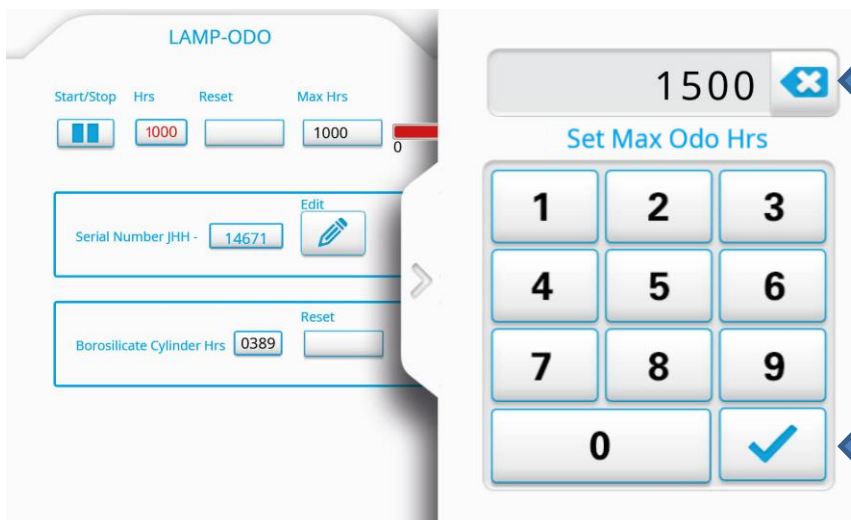

Using the keypad, set the number of hours required.

As an example, 1500 hours is entered as shown here

Once input select ✓ to enter, save & return to the 'LAMP-ODO' home screen.



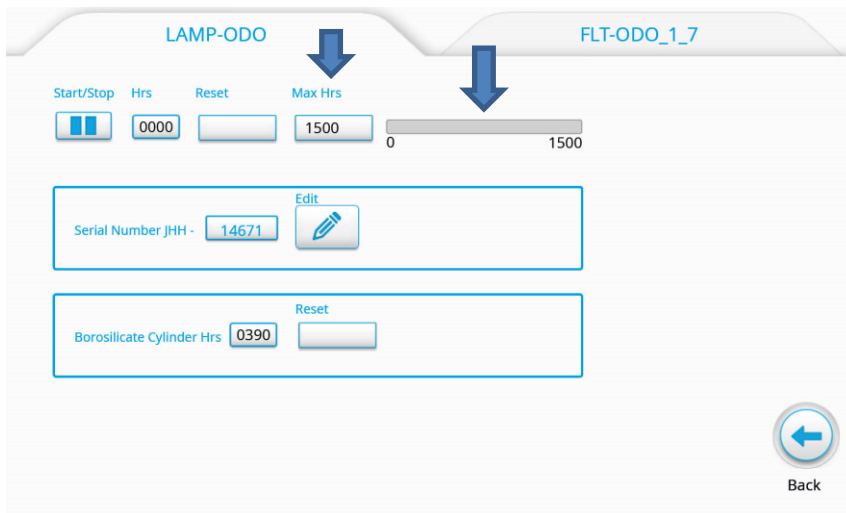

1500 Max Hours will now show and the progression bar will be completely empty & grey

The Max Hours for the lamp is now set.

**Borosilicate Cylinder Counter:**

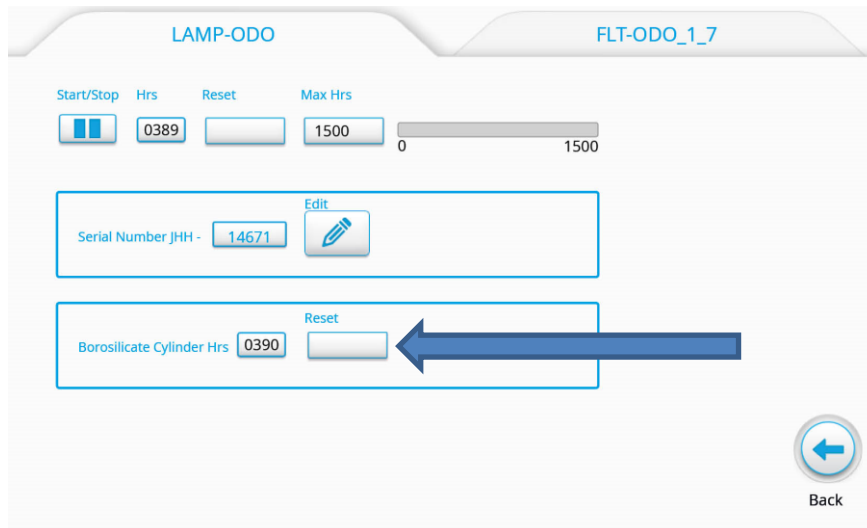

When the Borosilicate Cylinder is changed, press the Reset button to zero the counter.

There is no given lifespan for the Borosilicate Cylinder.

However, it is advisable to check it on each filter & lamp change & changed if any visible changes can be seen, e.g. chips, milkiness of the glass etc.

If a clean is required, then do so with a soft lint free cleaning cloth.

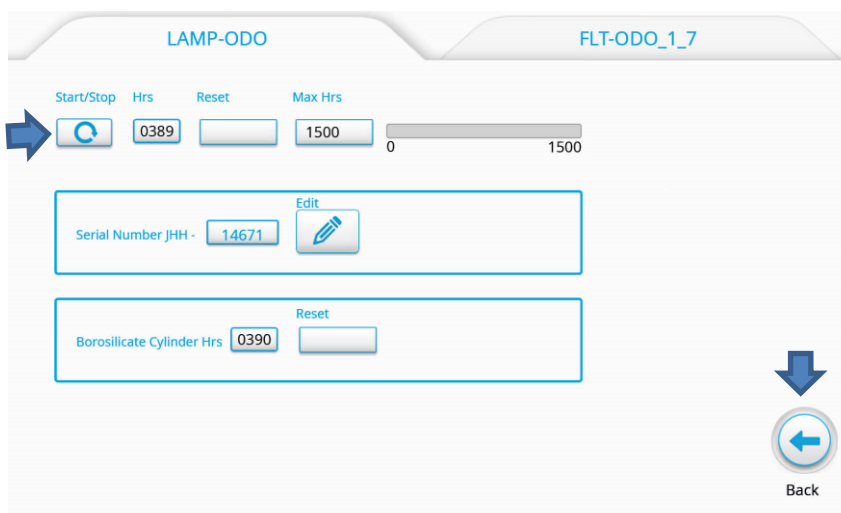

Once one or more required changes have been made, press the Start/Stop button to show the circular 'play' icon, so turning on the lamp odometer (counter).

Finally press the radial Back button to return to the GENERAL screen in Settings

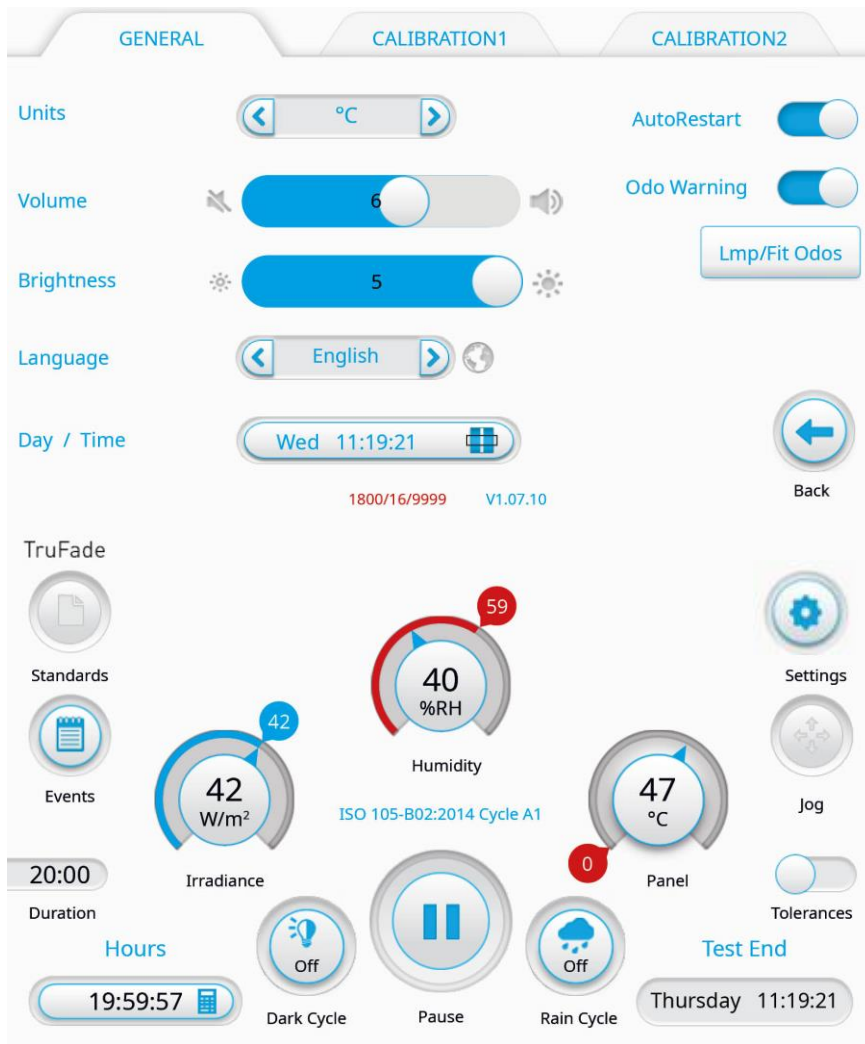

When in GENERAL screen in Settings press Back to return to the Home screen.



Home Screen

Note that there is now no warning exclamation mark in the top left corner of the screen.



*Note: This will only disappear once both the lamp and all filters which have exceeded their set life span duration have been changed and corresponding odometers reset.*

### Changing the Filter Odometer settings:

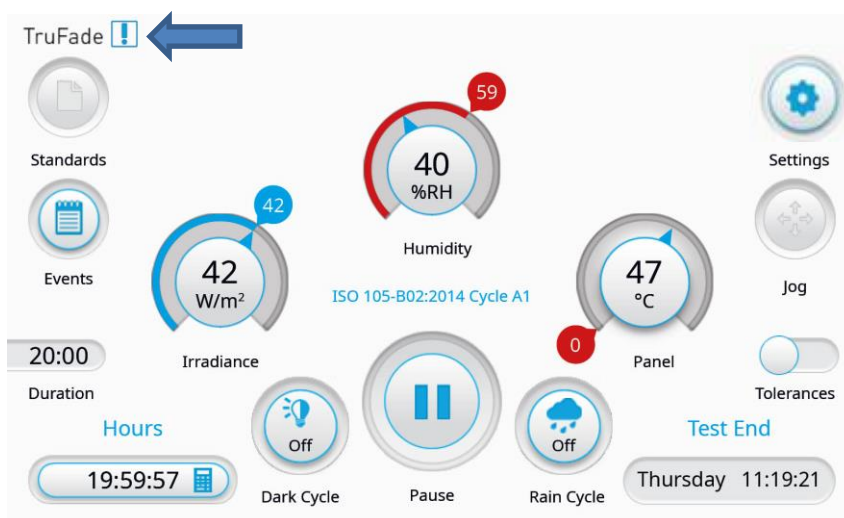

The Odometers have a warning alert when the set hours have been reached or will be reached during the duration of a test.

This is marked by an exclamation mark:



Access the GENERAL screen by selecting the 'Settings'. Tap on the radial button to select on the touch screen:





GENERAL Screen

When on the Odo Warning alert switch is toggled to the left.

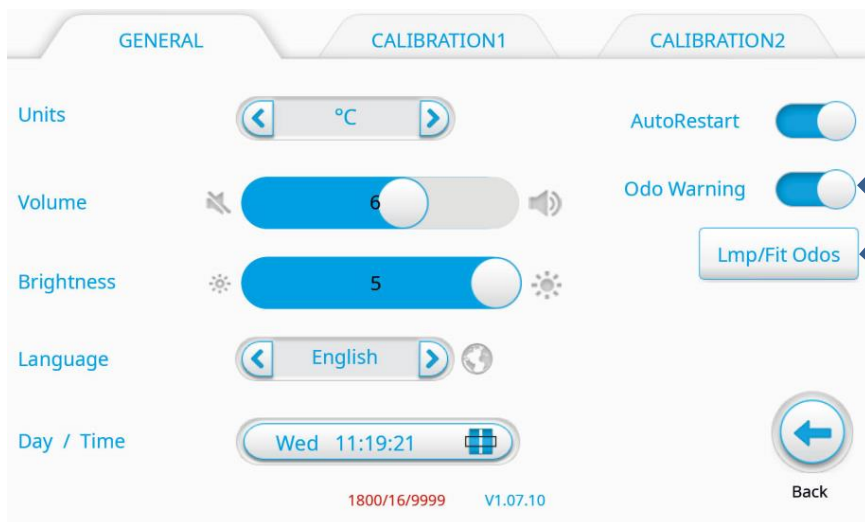

Ensure the Odo Warning button is toggled to the right and highlighted blue

To go to the Lamp & Filter Odometer (counter) menus, press the Lmp/Fit button.

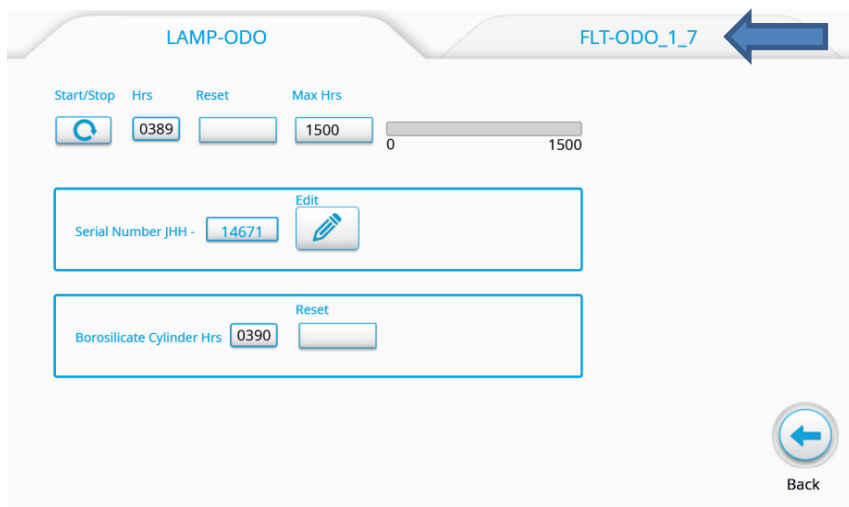

Now, select the filter odometer menu tab FLT-ODO 1-7

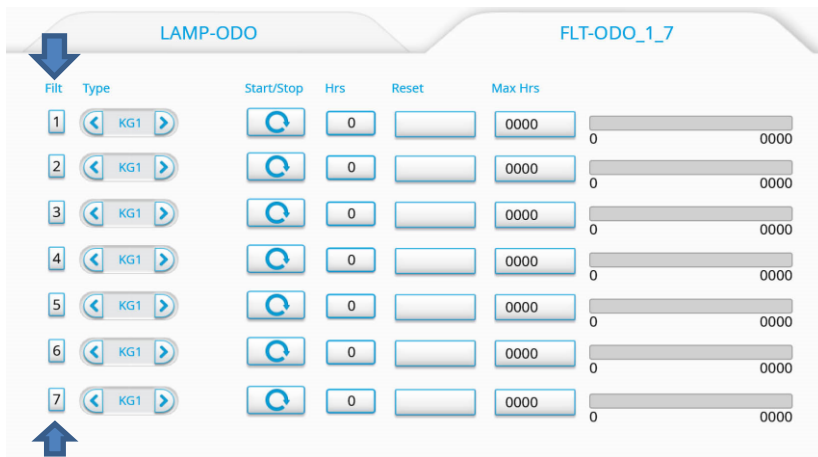

The filter odometer FLT-ODO 1-7 menu will appear.

The TruFade holds 7 lamp filters – one in each filter holder station within the Lantern Assembly (See 'Accessing Glassware' section of this guide).

Each filter holder station has its own parameter setting line listed 1 to 7 in the menu

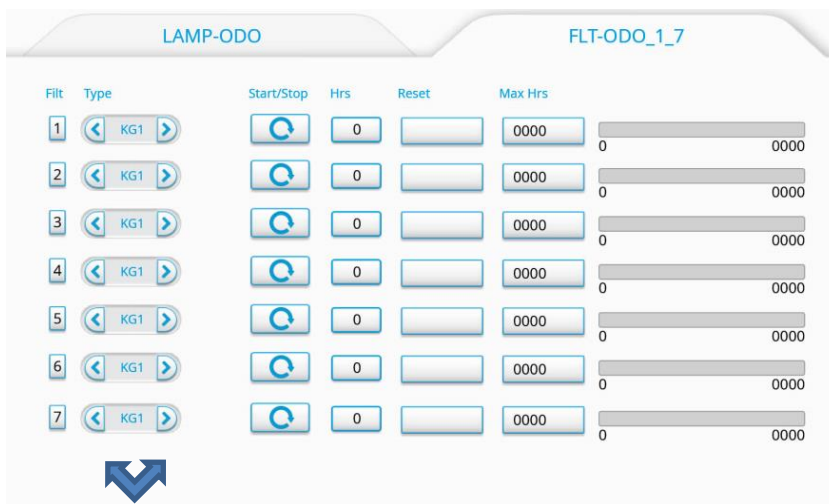

There are three different types of filters listed in 'Type': WG, KG1 and KG3 or UG11.

KG3 or UG11 is listed dependent upon the firmware installed.

Use the arrows to scroll through the types. Illustrated here the three types are KG1, KG3 & WG:



**Start**  / **Stop**  **Pause function:**

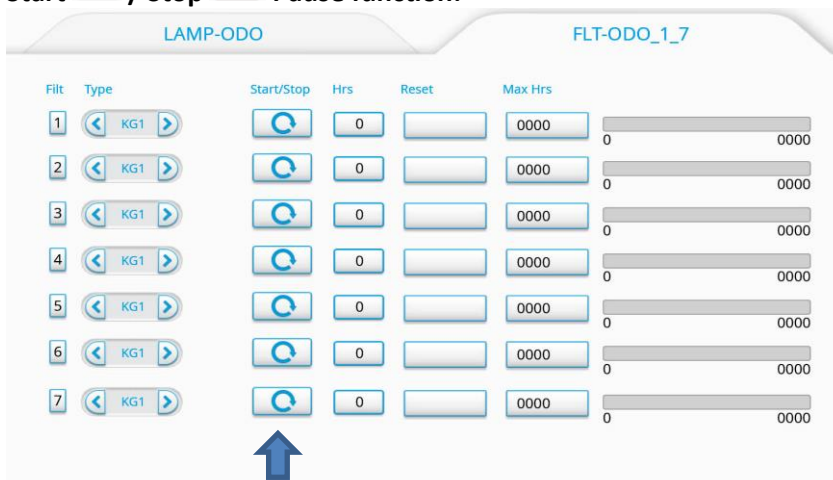

There is a Start/Stop button for use when filters are swapped in/out and ratios are changed.

When this 'Start' button is pressed:



The 'Stop' button appears as what is generally known as 'Pause' button:



The Start/Stop is used to pause the odometer counter. The purpose of this function is to keep a log of the number of hours a filter has been used for, even when not in use.

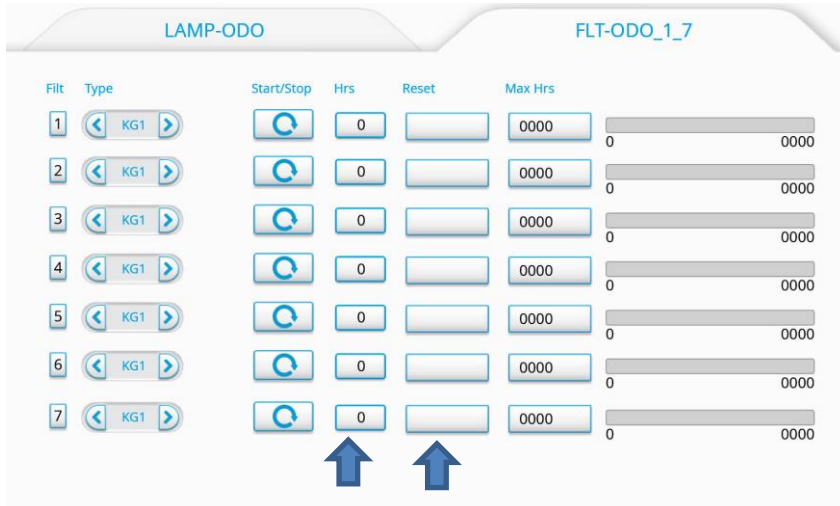

The accumulative counter for the number of hours for each filter is found in the 'Hrs' column.

To reset the accumulated number of count hours 'Hrs' press Reset

Here it is showing at zero as the count has not yet started.

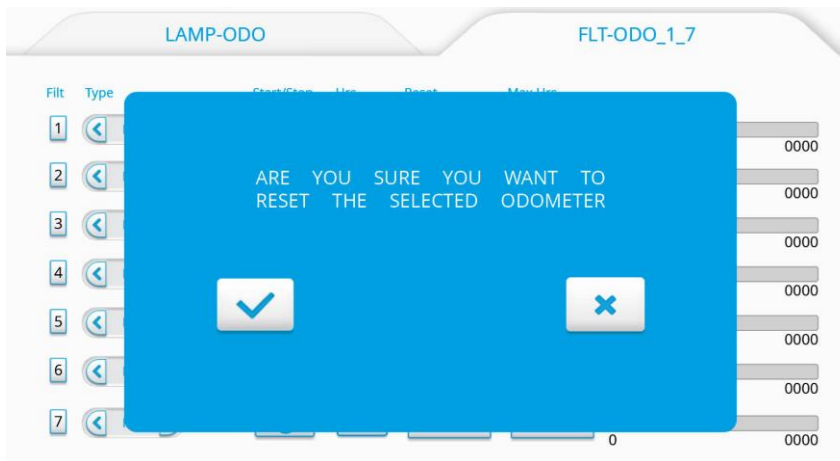

Once the required Reset station button is selected, the action verification screen will appear.

Select ✓

**Adding filter Maximum Hours (Max Hrs) duration for each filter:**

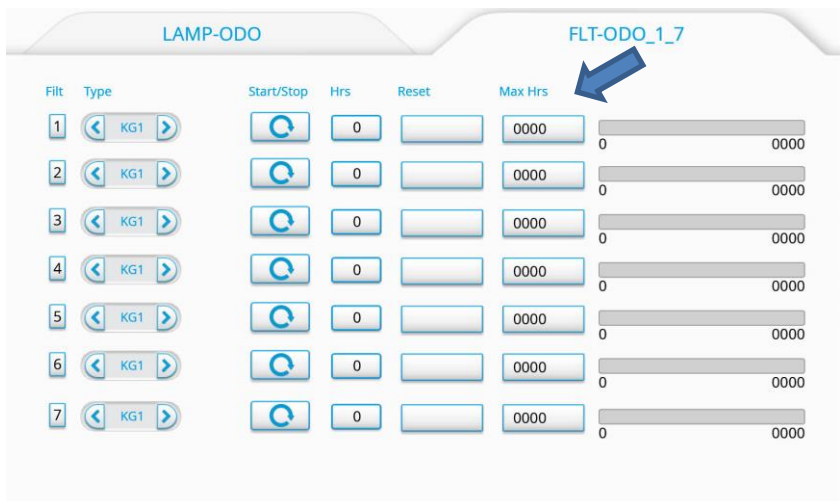

It is necessary to add an odometer for each filter, as each filter Type may have a different lifespan or each filter of the same type may be required to be changed in rotation e.g. KG1.

To alert the user to when it is time to change each filter, it is necessary to set the maximum number of hours of life each filter requires.

To set or change the Max Hours for each filter press the corresponding filter station Max Hrs button

In this illustration, we are setting the Max Hours for filter 1 (see arrow above)

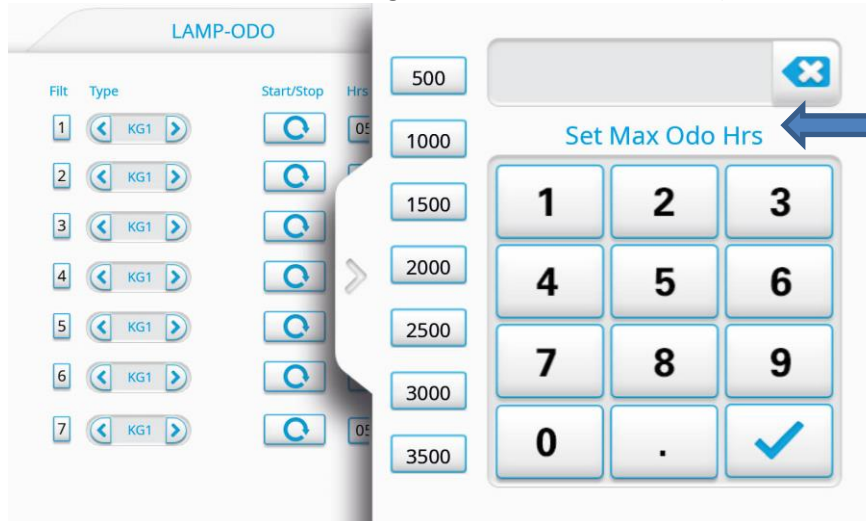

The Set Max Odo Hrs keypad will appear

Type in the required hours using the number keys or use the preset values to the left.

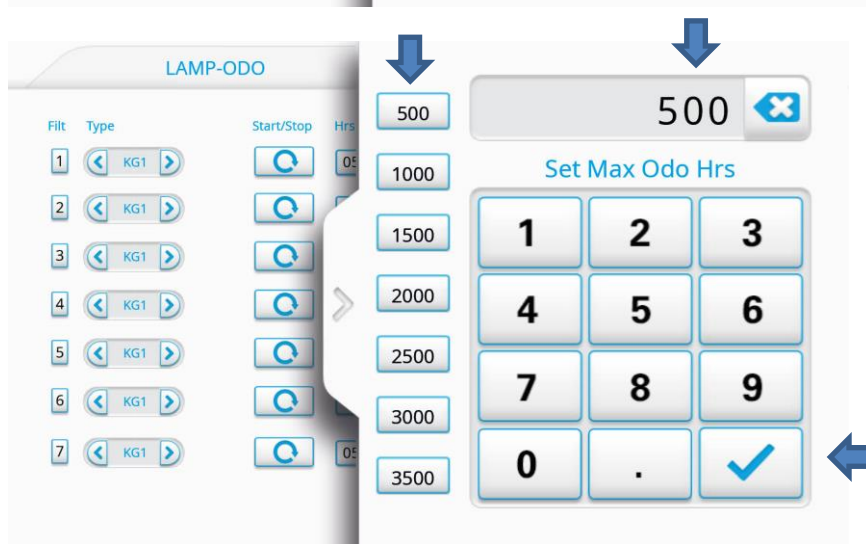

To set a preset value in one of the preset buttons, type the required number in.

Then press and hold one of the preset keys and the number will appear on the preset button chosen.

Select ✓ to save and return to the FLT-ODO 1-7 menu 500 in large box

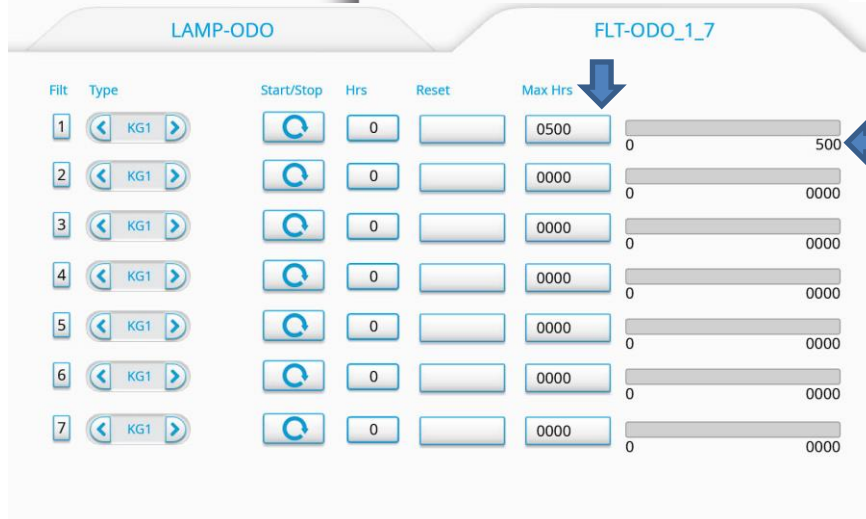

The selected filter station will show the now set Max Hrs and on the progress bar

Here 500 maximum hours (Max Hrs) have been set on Filter (Filt) 1 on the top line.

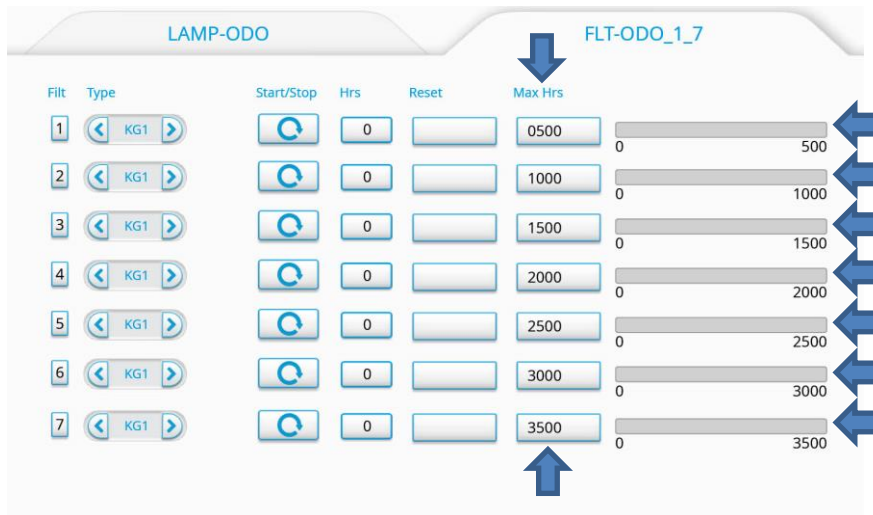

Repeat the actions given above for each subsequent station.

All Max Hrs have now been set on each filter (Filt) station number 1-7

### Maximum Filter Hours reached - Changing filters and resetting the filter Max Hours odometer:

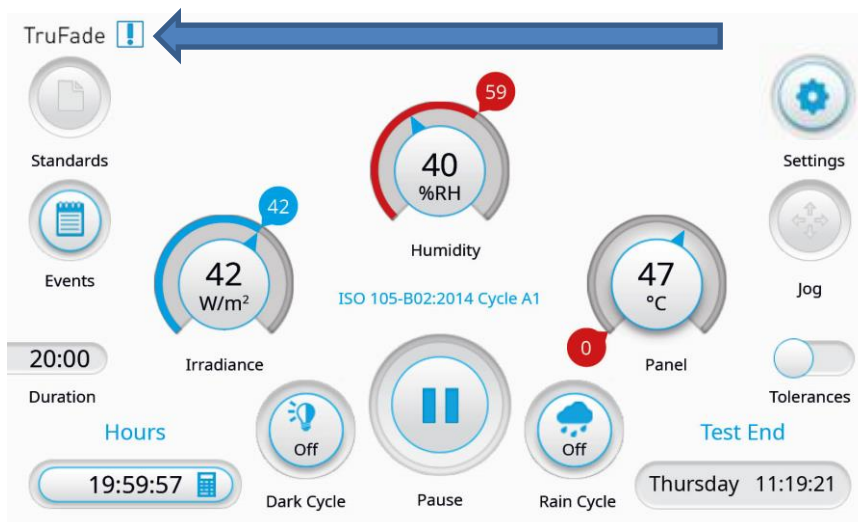

When the odometer warning alert exclamation icon appears in the corner of the home screen:

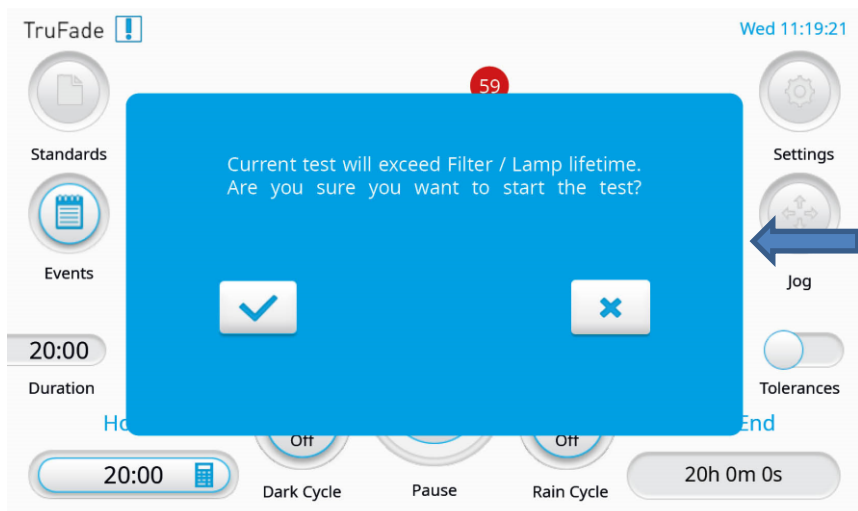

...And the warning/action verification screen appears at the start of a test/power up..

Select ✓

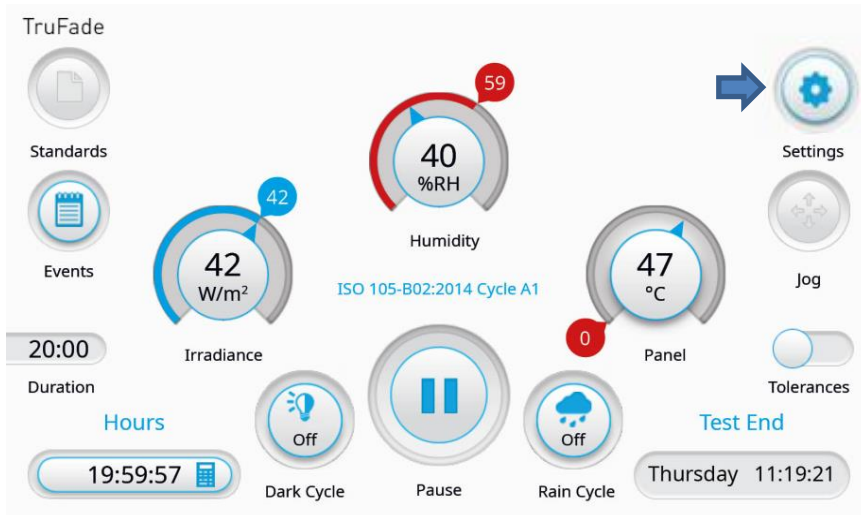

Press the Settings button to get to the GENERAL screen.

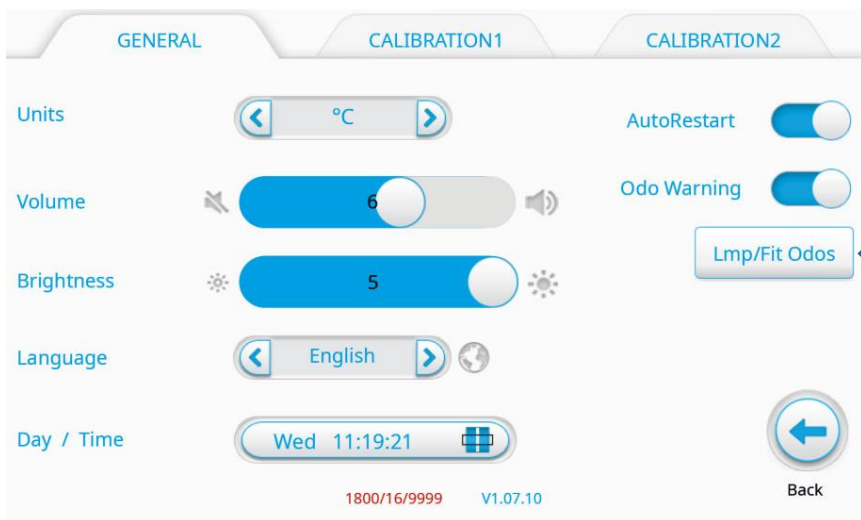

On the GENERAL screen, press the Lmp/Fit Odos button

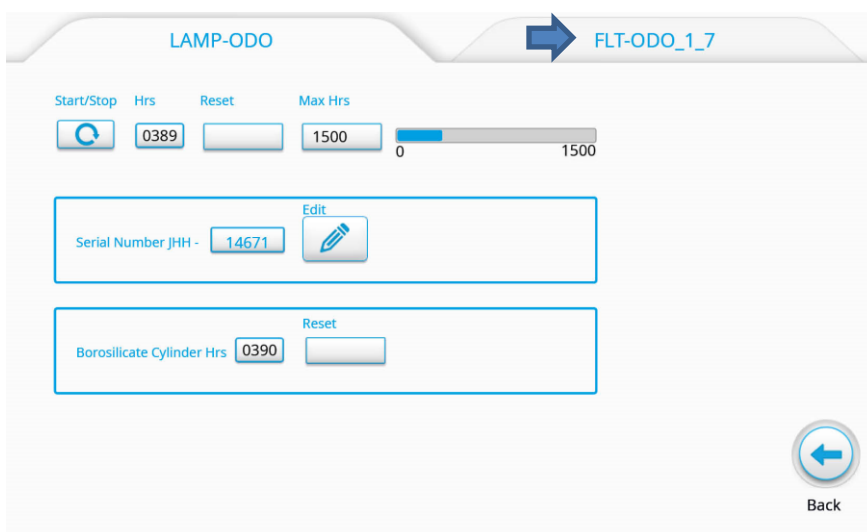

The LAMP-ODO menu will appear (first check if the Lamp life has been reached and conduct as previously instructed above in Lamp Odometer section of this guide).

If the LAMP-ODO settings are OK (as they are here), select the FLT-ODO 1-7 menu tab.



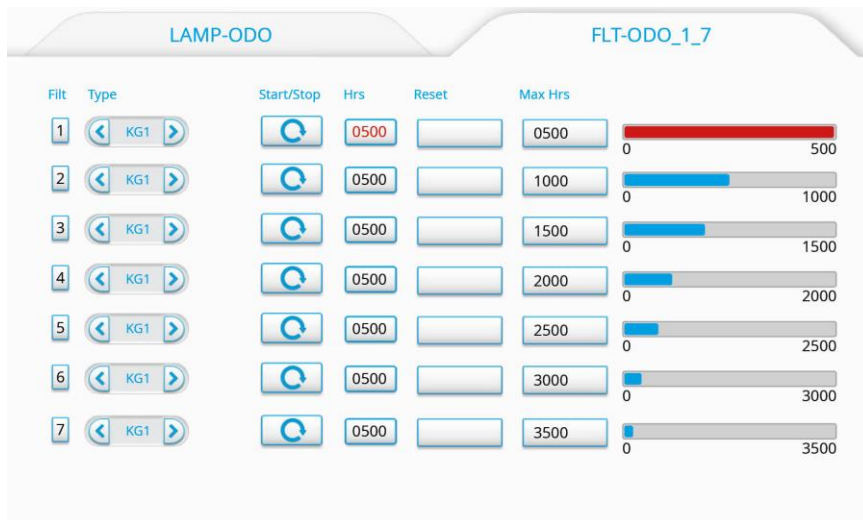

In screen FLT-ODO 1-7:

Locate the filter station number that indicates the filter has reached its Max Hrs – this is highlighted in red on the progress bar and in the Hrs counter.

Change the corresponding filter – In this example Filter 1 needs changing.



Change corresponding filter in lamp assembly

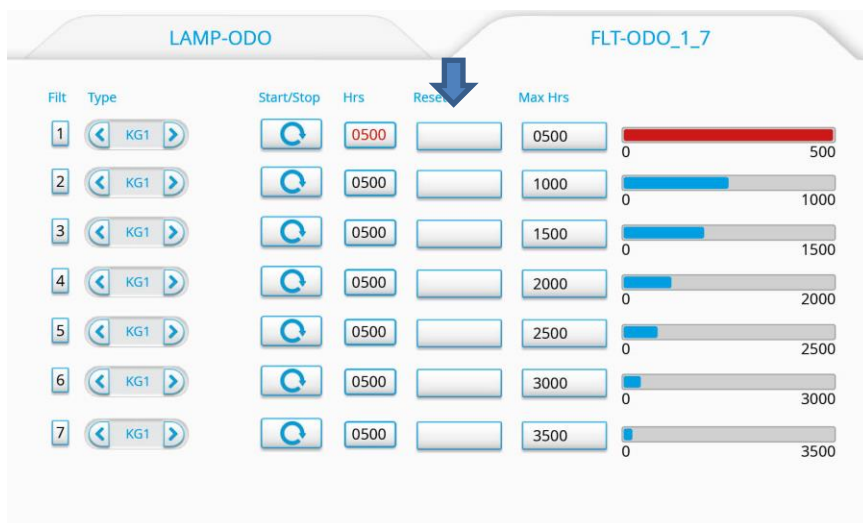

Select the Reset of the appropriate filter station e.g. Filter station 1

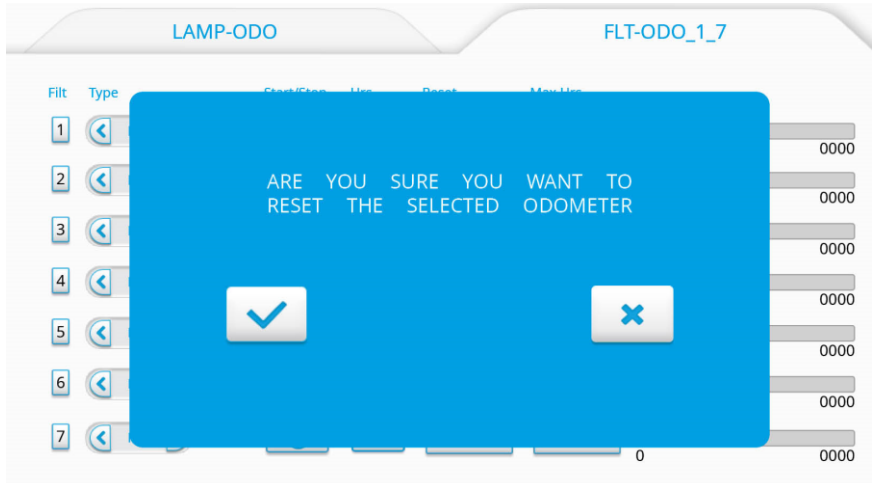

The action verification screen will appear.

Select ✓

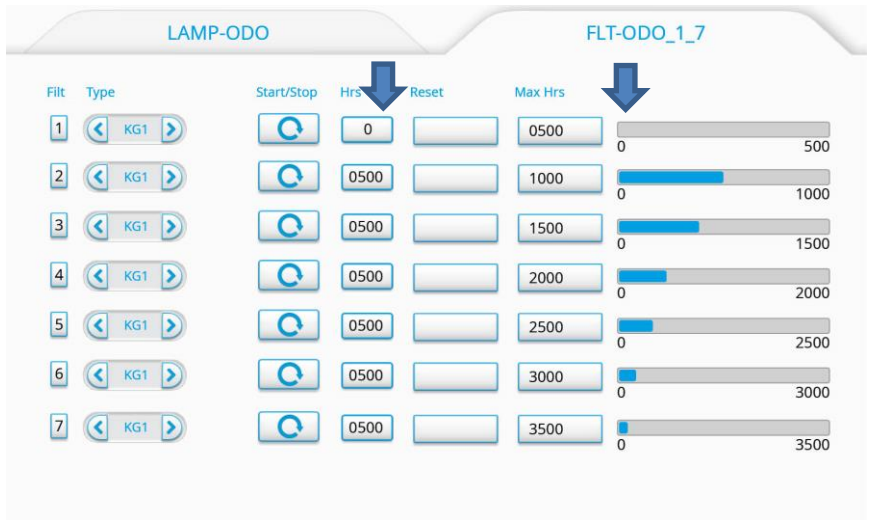

The Hrs counter will return to zero and the progress bar to empty & grey.

**Changing Filter Types:**

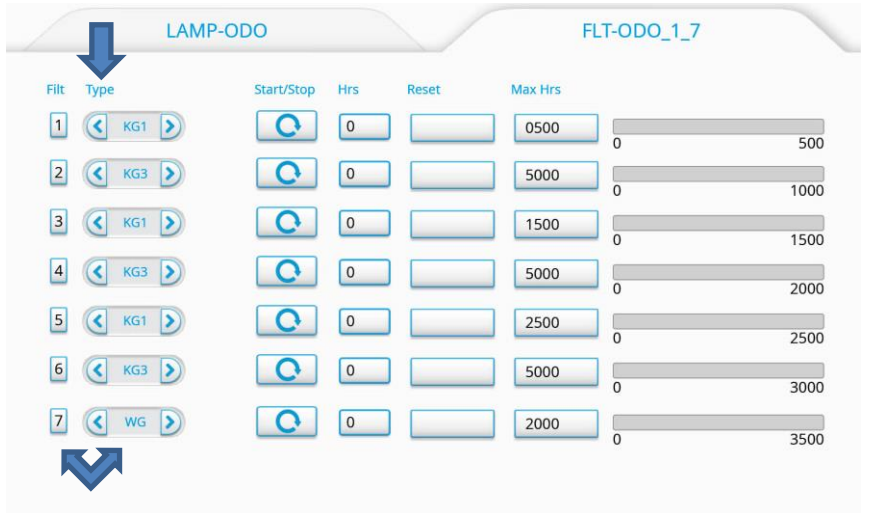

Scroll through the filter types to locate the correct filter for the corresponding filter position in the lamp assembly.

Where the different filters are required in the same lamp assembly, simply change the filter 'Type' by scrolling through the Type button to locate the filter name (e.g. WG) to that of the corresponding filter that sits in the chosen station position location in the Lamp Assembly (e.g. position 7)

(If a different filter was previously in this filter station number position remember to press Start/Stop to show 'Pause'  to stop this filter's odometer counter, before scrolling onto your required filter Type).

In the above example, filter station position 1, 3 & 4 are filter Type KG1; positions 2, 4 & 6 are filter Type KG3 and position 7 is filter

The maximum hours (Max Hrs) are all set in the same way as described previously in 'Adding filter Maximum Hours (Max Hrs) duration for each filter' section, regardless of Type.

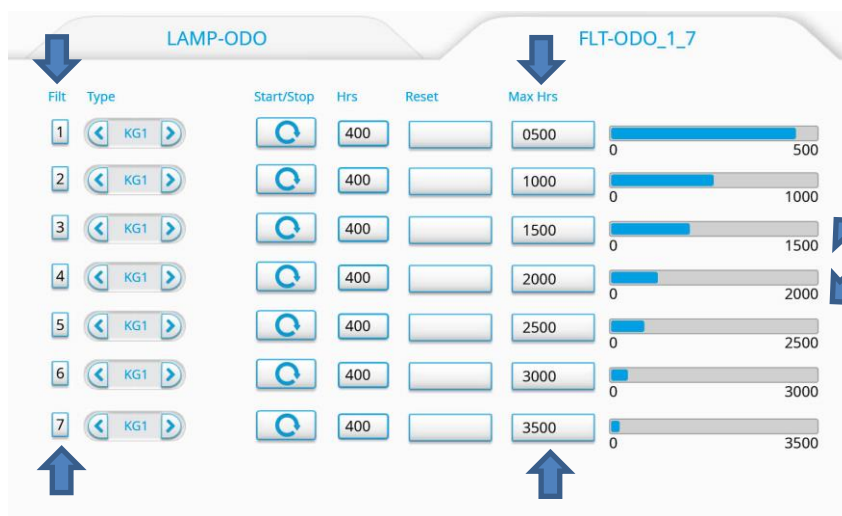

Once the required filters are in place and the machine is running the hours (Hrs) will count up and the progress bars will move along incrementally according to the maximum hours (Max Hrs) set.

KG1 as shown here have a combined total life of 3500 Hrs. (KG3 filters also have the same combined life duration).

In order to ensure uniformity of fade one filter is changed for a new one every 500 hours – working in a constant cycle starting with filter 1 and working through to 7 and then back to 1 again etc.

**Swapping out filters temporarily:**

When it is required that a filter be temporarily swapped out for another filter – For instance in order to create the correct conditions as required to conduct a particular test different to the filter arrangement currently in situ, then, do the following:

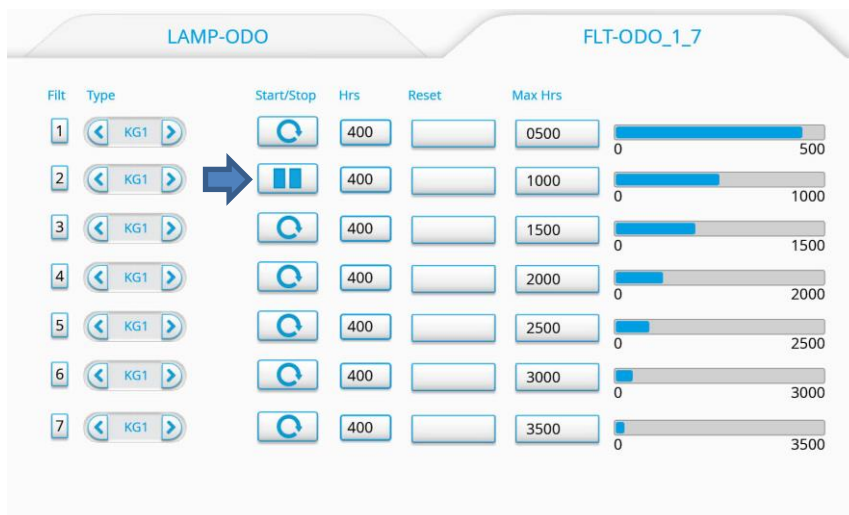

Decide upon which filters are to be changed in the Lamp Assembly and remove them.

Then, on the corresponding filter station parameters on the FLT-ODO 1-7 Menu, press Start/Stop to pause the Odo counter for that station filter number

Here Filter (Flt) station 2 has been paused.

Leave this to remain on pause until the same filter is replaced back in the Lamp Assembly at a later date.

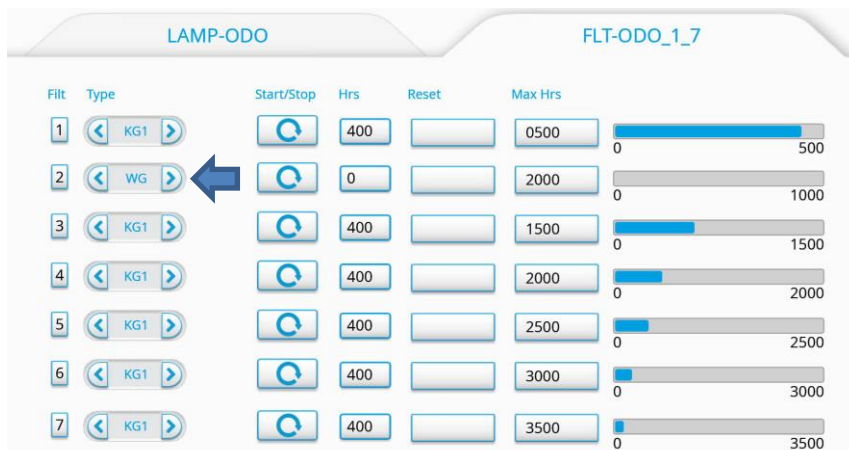





Replace the filter to the one required in the Lamp Assembly, then scroll through Type to find the filter type that is now placed in the filter station position e.g. WG

If it is a new filter set the Max Hrs and reset the counter (illustrated here and as described in 'Adding filter Maximum Hours (Max Hrs) duration for each filter' section).

Ensure the Stop/Start button is showing the radial play icon: 

OR

- If it is an existing filter that has previously been used in that station position before and is being put back into position after being removed temporarily, then that filter station number will be on 'pause' (as outlined in previous 'Start  / Stop  Pause function' section). Press the 'pause'  icon on the Stop/Start button and change it to Start by selecting the circular play icon  on the Stop/Start button.

The Odo count for that filter will then resume once more.

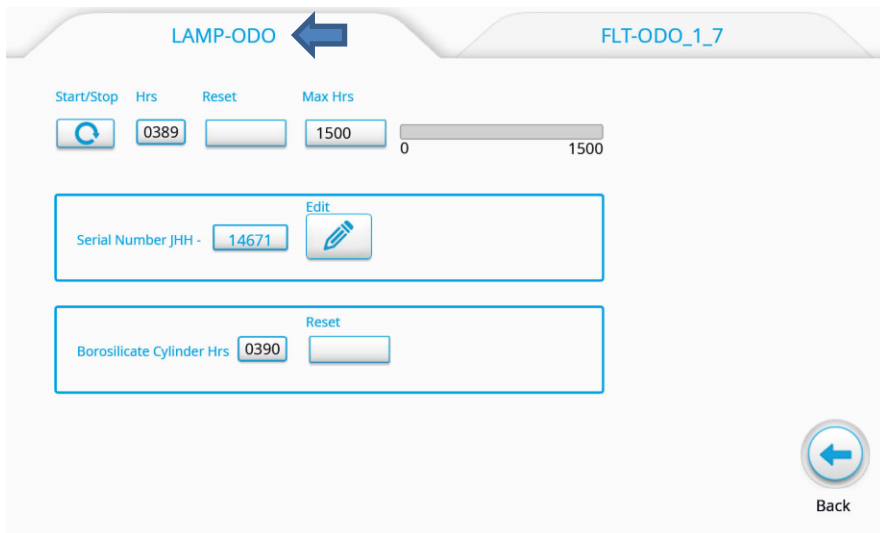

Once all the required changes have been made, go to LAMP-ODO screen and press Back button to return to the GENERAL screen

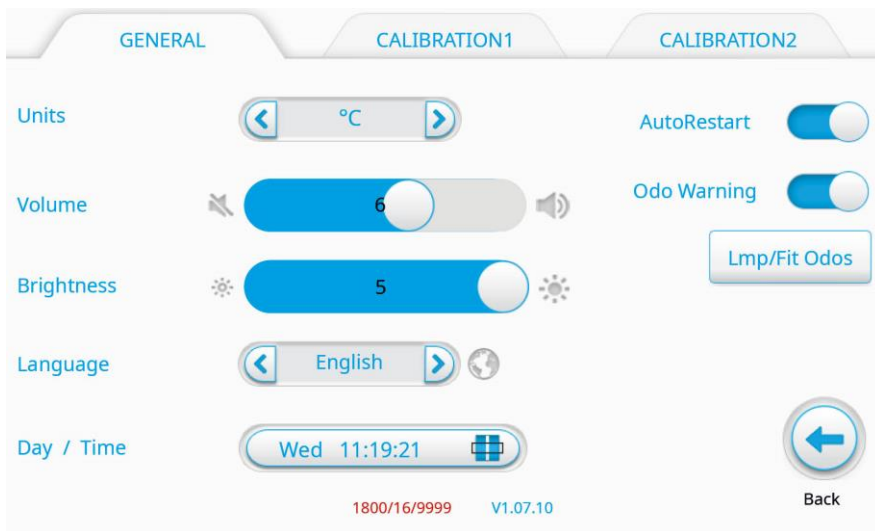

When in GENERAL screen press Back to return to the Home screen.

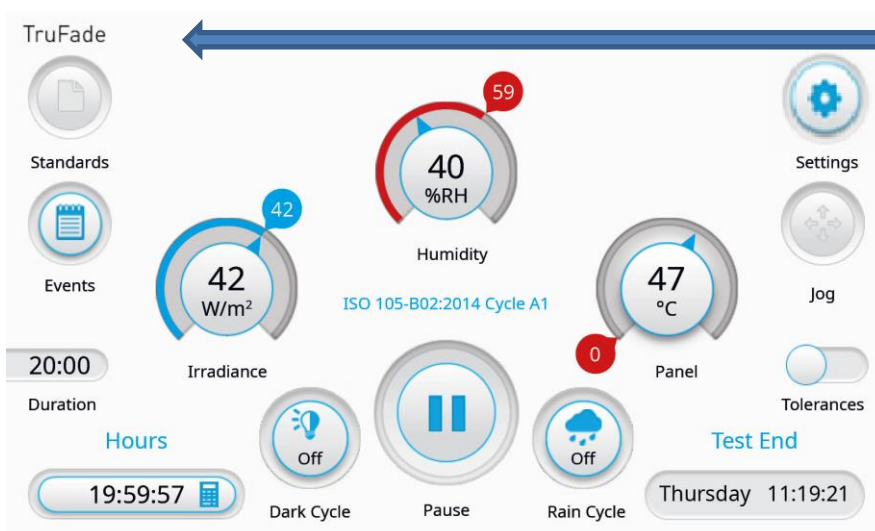

On Home screen: Note that there is now no warning exclamation mark in the top left corner of the screen.



## Updating TruFade Software (Firmware)



USB ports are found on the rear of TruFade. They are usually protected with rubber covers.

USB1 Type A (Top) is used to update the TruFade Software (Firmware) via a USB flash drive.

USB2 Type B is used by James Heal Engineers only.

TruFade 1800  
Rear/Back View

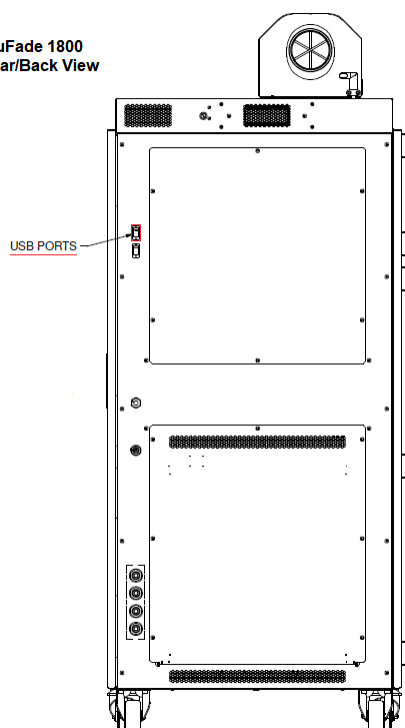

To update the TruFade Software (Firmware), you will require access to the rear/back side of the TruFade instrument.

Switch off the electrical power to TruFade.

Insert the USB Flash Drive containing the software update into the USB1 socket (the upper/top socket).

Switch on the electrical power to TruFade. TruFade will detect the new software and make the update. Please wait as the process will take a few minutes to complete.

During the update, the TruFade screen will display its progress using white text on a black background.

No interaction with the software will be required during the update.

When the update is complete, the updated software will start and TruFade will be ready for use.

Remove the USB Flash Drive from the USB1 socket. *If the USB Flash Drive remains in the USB1 socket then each time the TruFade is powered up it will make the update again.*

# ROUTINE MAINTENANCE BY USER

## Air Filters

Two air filters are used to protect the optical system from contamination by dust. These are inside the large front door. Dependant on the operating environment all air filters should be inspected at regular intervals and replaced as necessary.

The filters are accessed inside the large front door and then unscrewing the filter retaining mesh.



## Test Chamber Air Exhaust

Do not obstruct the air exhaust from the test chamber. If the temperature of the exhaust air exceeds 70°C then the TruFade will shut down.

If a flexible exhaust pipe is used, ensure it is not kinked, over bent, twisted, or dropped to the floor obstructing the outlet. Checked the final exit point for blockages.

## Optical Filters

KG1 and UG11 filters are sensitive to moisture and should only be cleaned with a clean dry lint free cloth. If water has to be used then do not soak the filters, then remove excess water and dry as soon as possible.

The Borosilicate Cylinder and Window Glass Filters can be cleaned with a mild detergent solution or glass cleaner that does not contain silicone, followed by rinsing with pure water to remove any residue. Allow to dry naturally.

Finger marks on optical filters should be avoided. Use cotton gloves for handling or hold them by the edges.

## Xenon Lamp

Never touch the quartz envelope of the xenon lamp. If the xenon lamp has been inadvertently handled you should clean the quartz envelope with isopropanol or methylated spirit (consult chemical suppliers MSDS) before running. Failure to do so will result in the lamp being permanently marked and potentially damaged.

## Water Supply

Use only (ISO 3696 grade 3) deionized water for the humidification system. Failure to do so will invalidate your warranty.

## Test Chamber

The test chamber may be cleaned with a liquid cleaning agent that does not contain chlorine or silicone. Rinse well to remove traces of cleanser with deionized water.

# MOUNTING SPECIMENS AND BLUE WOOLS

## Guide using the Tri-Sided Sample Holder

The TruFade uses a revolutionary Tri-Sided specimen holder in order to maximise the available test area.

Specimens are mounted on OBA-free white specimen card and placed in the specimen holder with a mask to ensure that comparison can be made between the irradiated and non-irradiated section of the specimen.

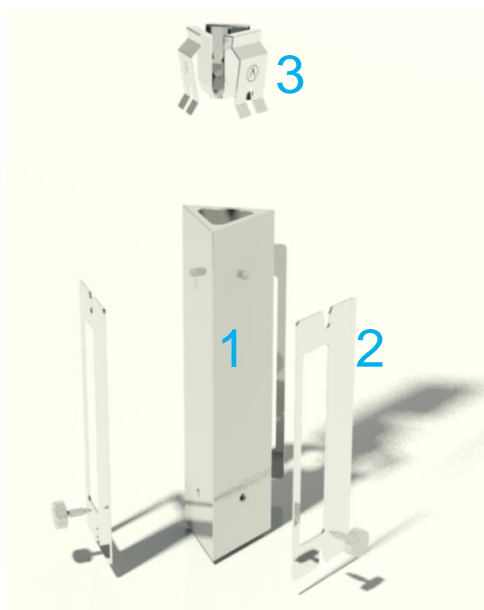

The easy to assemble Tri-Faced specimen holder consists of 3 main parts.

1. The main body
2. The specimen masks
3. The specimen mask clips

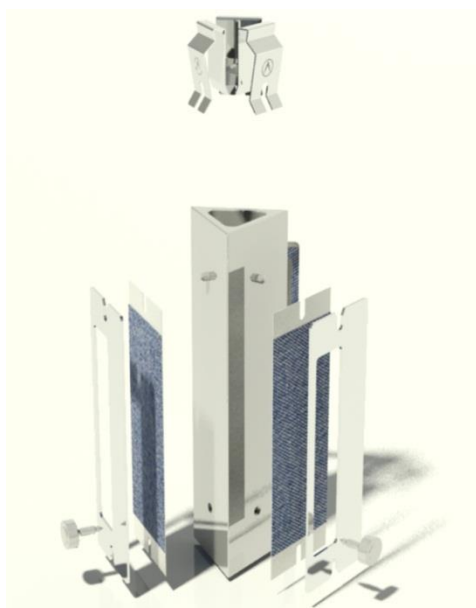

Your specimens and Blue Wool Wools are mounted on James Heal OBA free specimen card. This card has been designed to fit perfectly in to the Tri-Sided Specimen Holder.

Specimens are positioned between the main body of the specimen holder and the specimen mask.





Next fit the specimen masks to the main body of the specimen holder.

Do this by locating the notched edge on the specimen mask on to the location pin on the main body of the specimen holder.

This is highlighted by the blue circle on the picture.

Next attach the thumb screws in to the screw holes in the main body of the specimen holder.

This is highlighted by the Blue arrow on the picture.



Finally lower the clips down to securely attach the specimen mask to the main body of the sample holder.

Your specimens are now ready to test.

## Specimen Holders and Masks

- The standard specimen holders are designed to accept specimens with a maximum test area 100 mm x 45 mm, and up to 3 mm thick.
- Samples can be mounted to all 3 sides of the specimen holder and up to 9 specimen holders can be inserted into the carousel at any one time, giving a total of 27 specimen faces.
- **Note:** if using SolarSens for 'Black Standard Temperature (BST) Control' and/or 'Controlled Irradiance Mode', then only 8 specimen holders will be available.
- To insert specimen holders, open the test chamber door and locate the specimen holders on the triangular blocks on the machine carousel. There is a triangular recess on the bottom of the specimen holder that fits over the triangular blocks to secure the specimen holder to the carousel.
- Press the Jog button to rotate the carousel to access the blocks at the back of the chamber.
- When handling the specimen holders, ensure that you do not touch the specimen face as this may soil the test specimens and affect results obtained.
- Specimens are usually mounted onto OBA-free white specimen card via use of small staples, unless otherwise specified in the test method.
- Any material placed between the specimen and specimen holder may affect the specimen surface temperature and may ultimately affect the results obtained.
- If specimens are not being used in every specimen holder during the test, ensure that OBA-free card is placed in the unused specimen holders, unless otherwise specified in the test. This will ensure reproducible exposure and that the thermodynamics and light reflection within the test chamber remains relatively constant.
- A variety of masks are available to ensure that comparison may be made between the irradiated and non-irradiated sections of the specimens. Masks are specified within the test methods. See the next page for range of masks available.
- Masks, Specimen Mounting Card and other Test Materials should be ordered separately.

# ISO Specimen Masks

Specimen masks allow you to make comparisons between exposed and un-exposed areas of the specimen and any control materials used.

## Masks for ISO 105-B02: Method 1



571-152

Double slot masks giving 1/3 cover



571-155

Single slot mask giving 2/3 cover

## Masks for ISO 105-B02 : Method 2 are available as an optional accessory



571-157

Single slot mask giving quarter ( $\frac{1}{4}$ ) cover

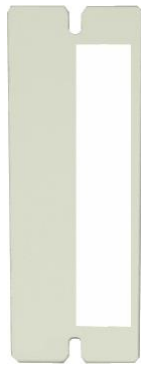

571-154

Single slot mask giving half ( $\frac{1}{2}$ ) cover



571-156

Single slot mask giving three-quarters ( $\frac{3}{4}$ ) cover

## AATCC Specimen Masks

Special AATCC masks are available to ensure that the exposed areas conform to AATCC specifications.



571-158

Double slot mask with exposed areas  
30x30mm



571-159

Double slot mask with exposed areas  
30x15mm

# TRUFADE GLASSWARE

This section describes how to fit the Xenon Lamp, access the Lantern Assembly and change Optical Filters and Borosilicate Cylinder.

## Installing or Replacing the Xenon lamp

When your Xenon Lamp has performed 1500 hours or when the instrument can no longer achieve the required irradiance levels, it is time to replace the lamp.

## Fitting or Replacing an Optical Filter

According to ISO 105-B02, the infra-red (heat absorbing) optical filter has a life of 3500 hours. TruFade has 7 infra-red optical filters (KG1), therefore the standard states that 1 filter shall be replaced in turn every 500 hours. This avoids testing conditions switching instantaneous from old filters to new filters, they are in a continuous state of renewal.

## UG11 Filter Placement for High Humidity Tests

UG11 filters are recommended for use with KG1s when testing to ISO 105 B02 A3 – High humidity, semi-tropical conditions test. Using all newly run-in glassware a ratio of 3 UG11s to 4 KG1s is advised. This ratio configuration allows for both A3 & A1 tests to be tested without the need to swap out any filters. (Please note that if only A1 'normal' temperate conditions tests are to be conducted on the machine then 7 KG1s are used as standard).

The ratio is glassware dependent. As the various components of the glassware ages and is changed for new at different rates, the ratio of UG11s to KG1 filters may need to be altered up to a ratio of 5:2 and down to 1:6.

A UG11 filter only needs replacing if it is damaged (cracked or broken) or shows visible signs of solarisation, which is when it begins to lose transparency and shows *any* degree of opaqueness. We recommend that the filters are inspected every 3500 hours maximum.

The unit should be run in a suitably conditioned lab. The ratios outlined were determined using ISO 139 conditions of 20°C ±2.0 °C and 65%RH ±4.0 %. If other conditions are chosen the ratios may need to be adjusted accordingly.

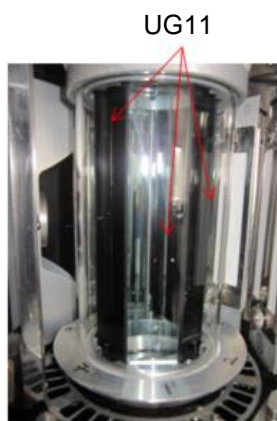

Example of UG11 & KG1 3:4 ratio placement

## Replacing Borosilicate Cylinder

The Borosilicate Cylinder only needs replacement if it is damaged (cracked or broken) or shows visible signs of solarisation, which is when it begins to lose transparency and shows *any* degree of opaqueness.

If the Borosilicate Cylinder becomes soiled with minerals from the water spray or because of poor quality water for humidification, then it can be washed in a solution of detergent (such as Neutracon® - <http://www.decon.co.uk/english/neutracon.asp>) followed by rinsing with deionized water and air drying.

## Accessing the Glassware

First, switch off the TruFade and isolate from the electrical supply.

If the TruFade has been in use then wait for at least 10 minutes to allow the xenon lamp and glassware to cool down sufficiently so that it can be handled safely.

The following scheme shows how to access the glassware components.

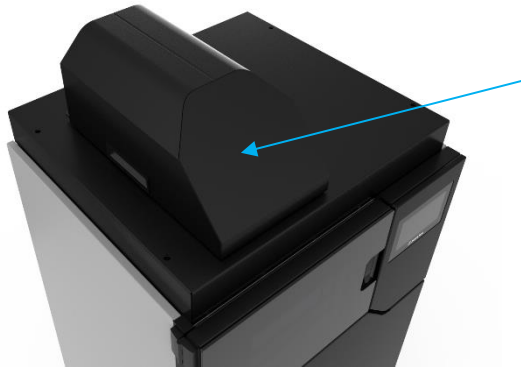

To access the glassware, the Exhaust Cover or Cowl needs to be removed.

You may require a step ladder to aid access to the top of TruFade.



Push the Cowl towards the back of TruFade.

Note: the Cowl is interlocked – if opened during testing then power to the Xenon Lamp will be shut down immediately.



Lift the Cowl upwards and out of the four (4) positioning holes.

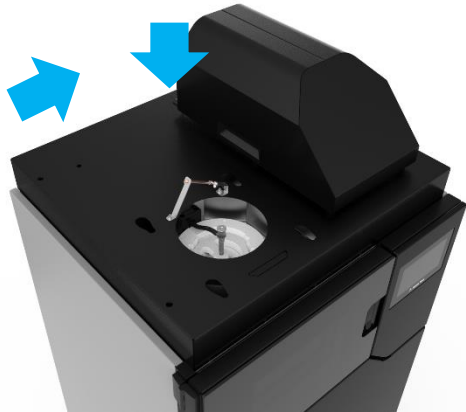

Place the Cowl on top of the TruFade to the right hand side.

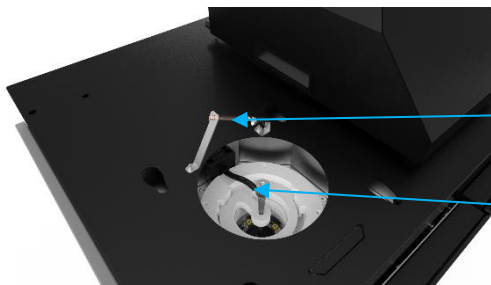

Exhaust Air Temperature Sensor

Xenon Lamp Electrode Connector (Ceramic)

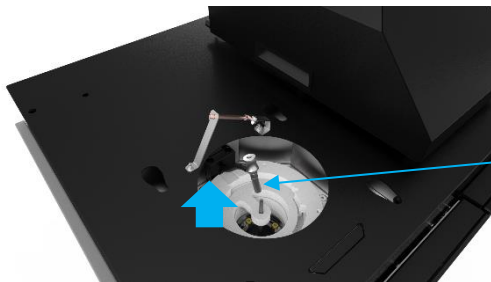

Lift the Ceramic Connector to disconnect from the Xenon Lamp

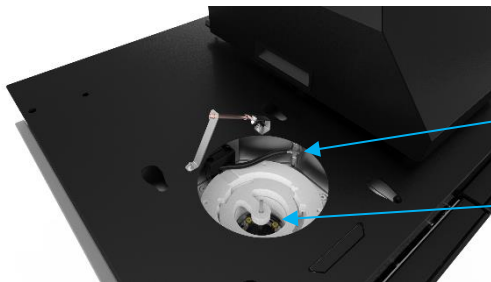

Move the Ceramic Connector to one side.

PTFE Electrode Holder

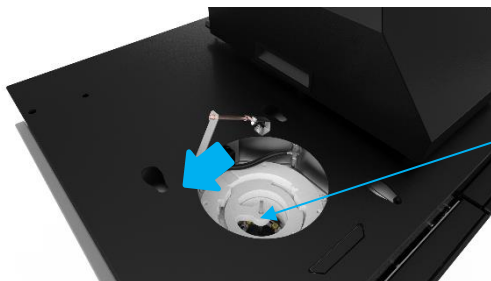

Rotate the PTFE Electrode Holder anti-clockwise by  $\frac{1}{4}$  turn



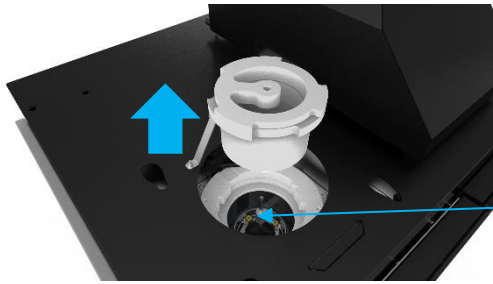

Lift the PTFE Electrode Holder vertically out of the TruFade. It will separate easily from the Xenon Lamp Electrode.

Xenon Lamp Electrode

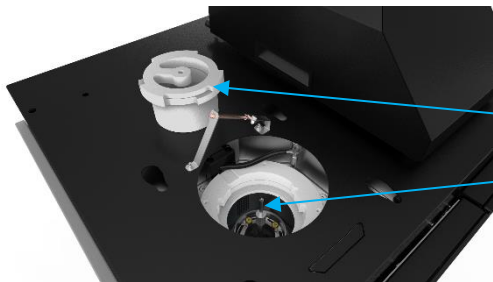

Place the PTFE Electrode Holder to one side.

Xenon Lamp Electrode



Take hold of the Xenon Lamp Electrode and lift the Xenon Lamp vertically out of the TruFade – there will be a small resistance as the lower electrode separates inside TruFade.

It is good practice not to touch the glass part of the Xenon Lamp with bare hands – use the cotton gloves provided if required.

Place the Xenon Lamp in a safe place.

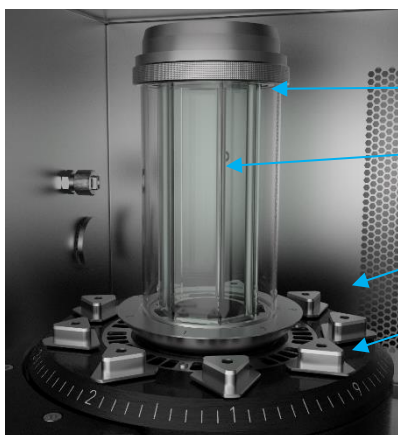

Inside the Test Chamber:

Borosilicate Cylinder

Optical Filters

Sample Holder Positions

Carousel / Turntable

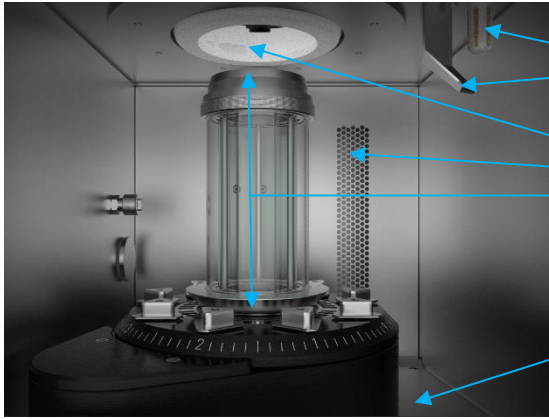

- Humidity Sensor
- Humidity Sensor Baffle
- Xenon Lamp Cooling Air Outlet
- Chamber Air Outlet
- Lantern Assembly
- Chamber Floor  
– Slopes Downwards Towards Back

Spray Nozzle for Weathering Testing

Calibration Port  
(James Heal Engineers only)

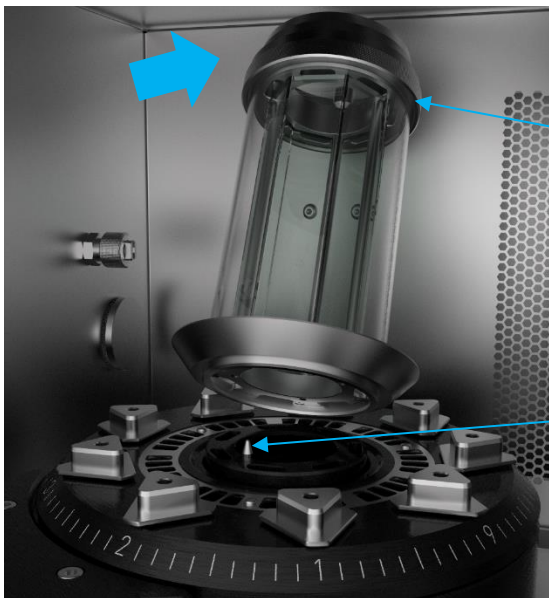
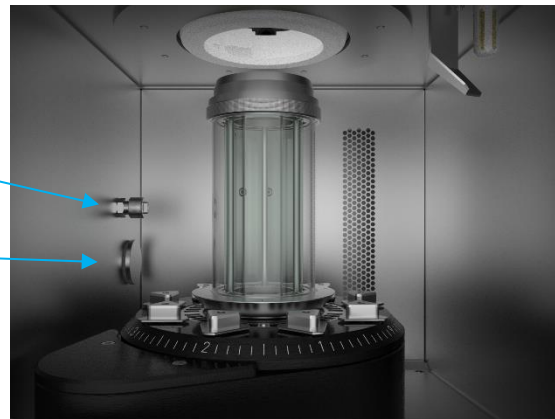

To remove the Lantern Assembly from the Test Chamber, first tilt the top of the Lantern backwards.

With the Lantern Assembly remaining in the tilted position, withdraw the Lantern from the Test Chamber.

Note the Locating Pin which mates with the notch on the underside of the lower ring of the Lantern Assembly.



Place the Lantern Assembly on a flat and clean bench



Unscrew the three (3) knurled brass nuts by hand, and place on the bench



Lift out the top Locator and place on the bench

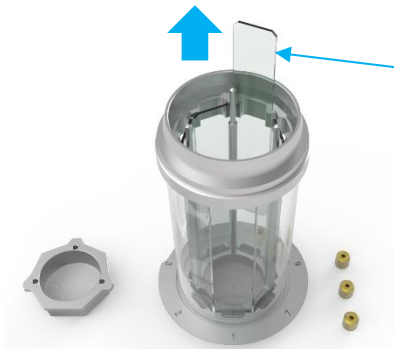

Carefully lift out the Optical Filter(s) and place on the bench.

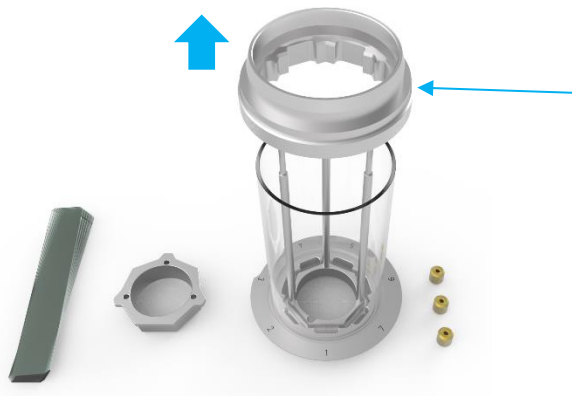

To access the Borosilicate, lift off the top ring of the Lantern Assembly, taking care to keep the seals.

*Note the seals are required to keep the Lantern Assembly water tight.*

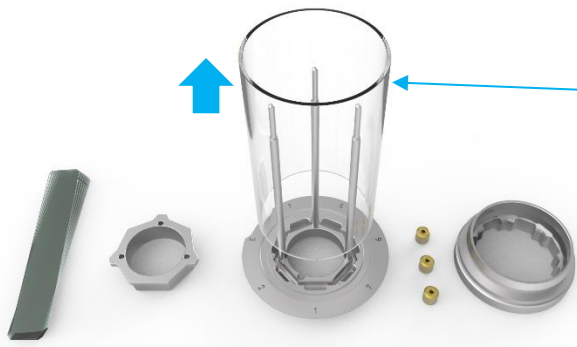

Lift out the Borosilicate Cylinder, taking care to keep the seals.

*Note the seals are required to keep the Lantern Assembly water tight.*

Reverse the process to re-assemble the Lantern Assembly and replace in the Test Chamber, then reverse the process to replace the Xenon Lamp.

## The Xenon Lamp

Stock Code: 106-800

The light source in TruFade is a long arc 2200 watt, air cooled xenon lamp, which requires special handling. Never touch the glass envelope, always handle the lamp by the metal connectors at each end.

The xenon lamp (often referred to as a xenon burner) is positioned as shown in the diagram below.

The intensity of the light emitted from the Xenon lamp reduces as the lamp ages. This fall off of intensity is compensated for by gradually increasing the lamp power through the life of the lamp when operating in irradiance mode.

For your safety it is not possible to have the xenon lamp switched on and the chamber door open, the front access door open or the top cover open.

The chamber access door has special optical properties that attenuate and remove the potentially harmful ultraviolet radiation from the xenon lamp.

## Fitting the Xenon Lamp

If replacing the lamp then ensure the TruFade is cool before attempting to carry out the lamp replacement.

Switch the isolator to the off position.

Open the top cover of the TruFade.

Remove the new lamp from the packaging, taking care not to touch the quartz glass envelope. Handle by the metal ends only using the cotton gloves provided in the package.

Carefully push the xenon lamp into the lower connector. Check the lamp is correctly located via viewing its position through the lantern arrangement. It should appear in the middle of the lantern.



The Operator must place the xenon lamp with the larger diameter connector in first (at the bottom) and ensure that the lamp electrodes fits correctly, and tightly, onto the top end connection of the lamp.

**Damage may occur if the lamp is not fitted correctly.**

# GENERAL PRINCIPLES OF LIGHT FASTNESS TESTING

## Specimen Temperature

Including setting black standard or black panel temperature.  
Specimen temperature is important as it has an effect on the rate of fade of the specimen.  
There are two methods of controlling and/or monitoring specimen temperature:

1. Black Standard Thermometer (BST) via SolarSens
2. Black Panel Thermometer (BPT)

Both are designed to show the maximum surface temperature a specimen could reach.

Prior to running test specimens, it is recommended that the test programme is run to ensure that the black standard/black panel temperature is correct. Please see below for more details.

## SolarSens and Black *Standard* Thermometer

SolarSens may be utilised to automatically control the Black *Standard* Temperature (BST).

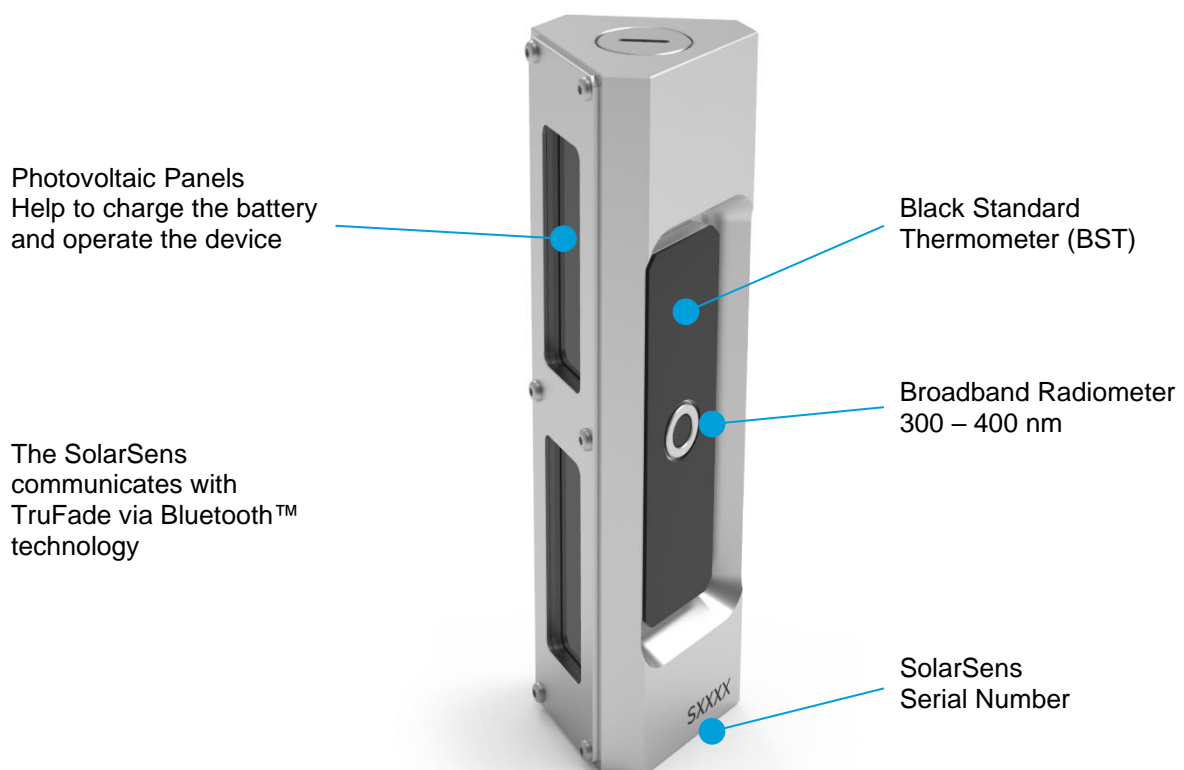

### 794-103 – SolarSens for TruFade 1800

## Black Panel Thermometer (BPT)

The Black Panel temperature is controlled by the Chamber Temperature setting in the selected Standard. If the Black Panel temperature is too low, increase the Chamber Temperature setting in the Standard definition.

To check the maximum specimen temperature, ensure either the SolarSens or BPT are in the test chamber and run the TruFade for at least 60 minutes. After this warm-up period, the Black Standard Thermometer or Black Panel Thermometer temperature reading will have stabilised.

When using BPT, view the temperature on the panel, through the chamber door window.

Due to the high temperatures these thermometers may reach, it is advisable to wear gloves when handling them. Use SolarSens/BST or BPT regularly to check the temperature, or whenever a Standard is changed.

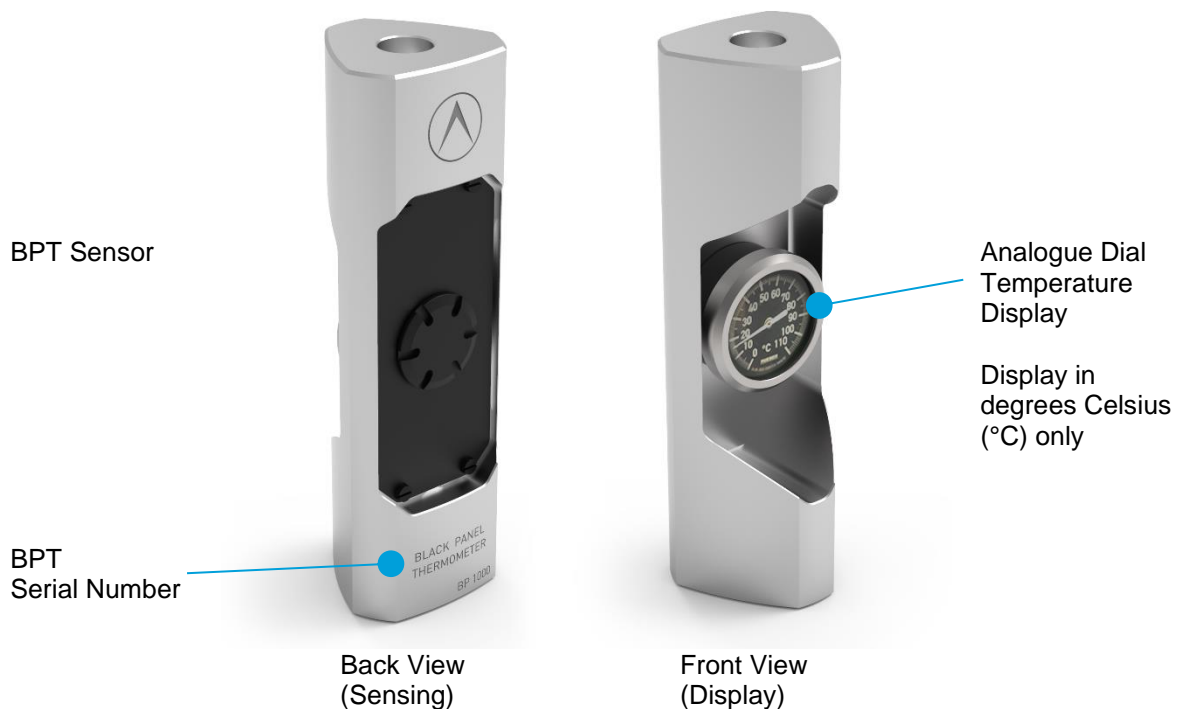

**751-250 Black Panel Thermometer**

# The Concept of Effective Humidity

ISO 105 B02 specifies that users should set and check the Effective Humidity every 3 months. Annex E in EN ISO 105-B02: 2014 says:

The frequency of verification is likely to vary according to the volume of testing and frequency of testing. Constant use or infrequent use interrupted by periods of disuse can both lead to potential changes in the effective humidity and, if allowed to go unchecked, would cast doubt on the validity of the test results produced.

It is recommended that verification should be carried out at least every three months. For machines which have not been used or verified within the last three months, it is strongly recommended that this is carried out prior to using the machine or at the same time as the testing is performed. Test results obtained at the same time as verification will be invalid if the verification does not meet the required conditions.

Irrespective of the frequency of verification, it is recommended that the test cards are retained for later reference and to allow visual comparison of different test cards over a prolonged period of time. This can act as a useful tool in detecting any drift in control of the effective humidity over time. All test cards should be stored in the dark.

In order to make light fastness testing instruments from different manufacturers comparable, Test Methods generally refer to measurable parameters rather than specific machine settings. Therefore, it is important to distinguish between Effective Humidity and Chamber Humidity. The Effective Humidity, as measured by the Humidity Test Control Fabric, is the level of humidity the test specimen experiences at its surface. Chamber "Relative Humidity" is measured electronically and monitored continuously. It is not practical to continuously monitor the Humidity Test Control Fabric and so the Chamber Humidity is used as an indirect means of achieving the desired Effective Humidity.

In TruFade, an Effective Humidity of 40% is achieved (when the instrument is located in an air conditioned room at 20°C and 65% RH) with the Chamber Humidity set at approximately 40%. Chamber Humidity is a set point used to achieve the desired Effective Humidity.

## Humidity Test Control Fabric

Described in EN ISO 105-B02 is a method for determining the effective humidity of a test chamber. This is based on the use of cotton fabric dyed with a red azoic dye. This method is summarized below.



## Obtaining 40% Effective Humidity

Mount and partially cover a strip of the Humidity Test Control Fabric (red azoic dyed cotton fabric) and Light Fastness Standard 5 in the normal manner and expose until one or both have faded to an extent visually equal to Grey Scale Grade 4. Compare the amount of fading on the two strips.

If both have faded to the same extent, the lamp was operating at the preferred effective humidity of 40%.

If the Humidity Test Control has faded more than Standard 5, the effective humidity is too high and the chamber humidity must be lowered and the exposure repeated.

If Standard 5 has faded more than the Humidity Test Control, the effective humidity is too low and chamber humidity must be raised and the exposure repeated.

James Heal Stock Code	Description
766-476	ISO Humidity Test Control Fabric - per pack (25 x 15cm)
766-315	ISO Blue Wool Standard No. 5 - per pack (1 piece 23 x 15cm)
766-200	Grey Scale for Assessing Change in Colour ISO 105-A02

## Determining Effective Humidity

Determine the colour fastness to light of the Humidity Test Control Fabric by the method described in EN ISO 105-B02: 2014. The effective humidity during the period of exposure can be obtained from the graph below.

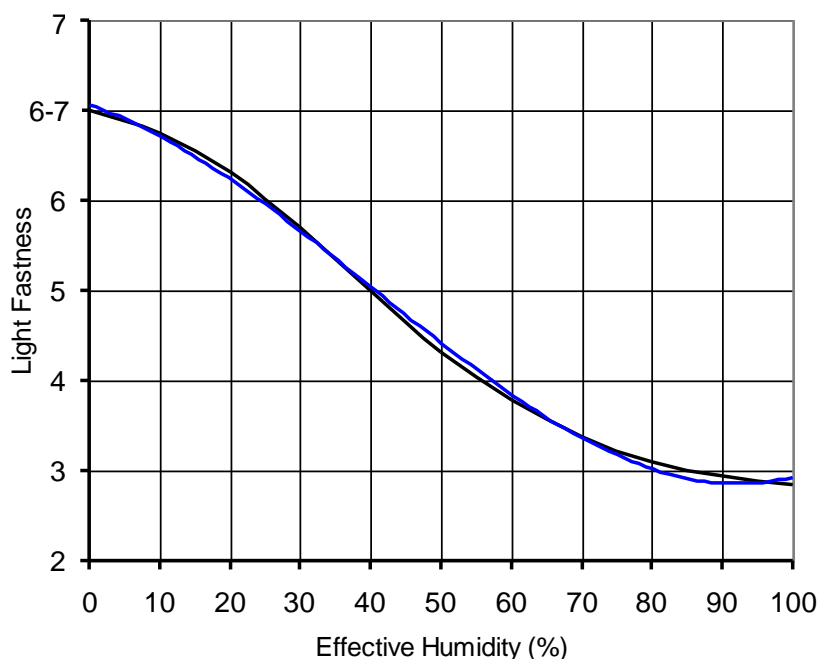

## Blue Wool Mode (Nominal Power Mode)

Blue Wool Reference standards have been utilized for many years to determine the end point of testing and to assess specimen fade. Typically, two sets of Blue Wools Reference standards are available:

- European (Blue Wool 1-8)
- USA (L2-L9).

*Note:* at December 2018, only L2 is commercially available.

The Blue Wool Reference standards are mounted on OBA free card and exposed to light and weathering procedures simultaneously with the tested specimens. At the end of testing, the specimens are compared to the Blue Wool Reference Standards and assessed accordingly.

To operate in Blue Wool mode (also known as nominal power mode), select the required Standard, then before starting the test, press and hold the Irradiance button, after a few seconds it will display "BW" (Blue Wool). The xenon lamp will then run at a nominal 75% power and the irradiance will not be controlled.

*Note: SolarSens is still required so that the Black Standard Thermometer readings can be taken and controlled.*



While the test is running, the Irradiance Dial will look similar to this, the actual irradiance value being displayed in the halo.

## Controlled Irradiance Mode

Although many light fastness standards use blue wools as a means of grading the amount of fade, defining the level of irradiance is now becoming more popular.

SolarSens is used to measure the light. It then uses this data in a continuous feedback loop to keep the light output constant by adjusting the lamp power as required. In line with AATCC and ISO test methods, SolarSens uses a broadband sensor measuring at a wavelength range of 300-400nm. Ensuring the correct lamp power output is consistently maintained during the entire test and the entire life of the lamp.

Tests can be performed to a specific total irradiance (dosage), or again, Blue Wool Reference Standards can be utilized at the same time as SolarSens to determine the end point of the test. The Blue Wool Reference Standards are also used to assess the fading of the specimens.

When using SolarSens to control the level of irradiance, testing times are more predictable as the light is dosed continuously at the same rate.

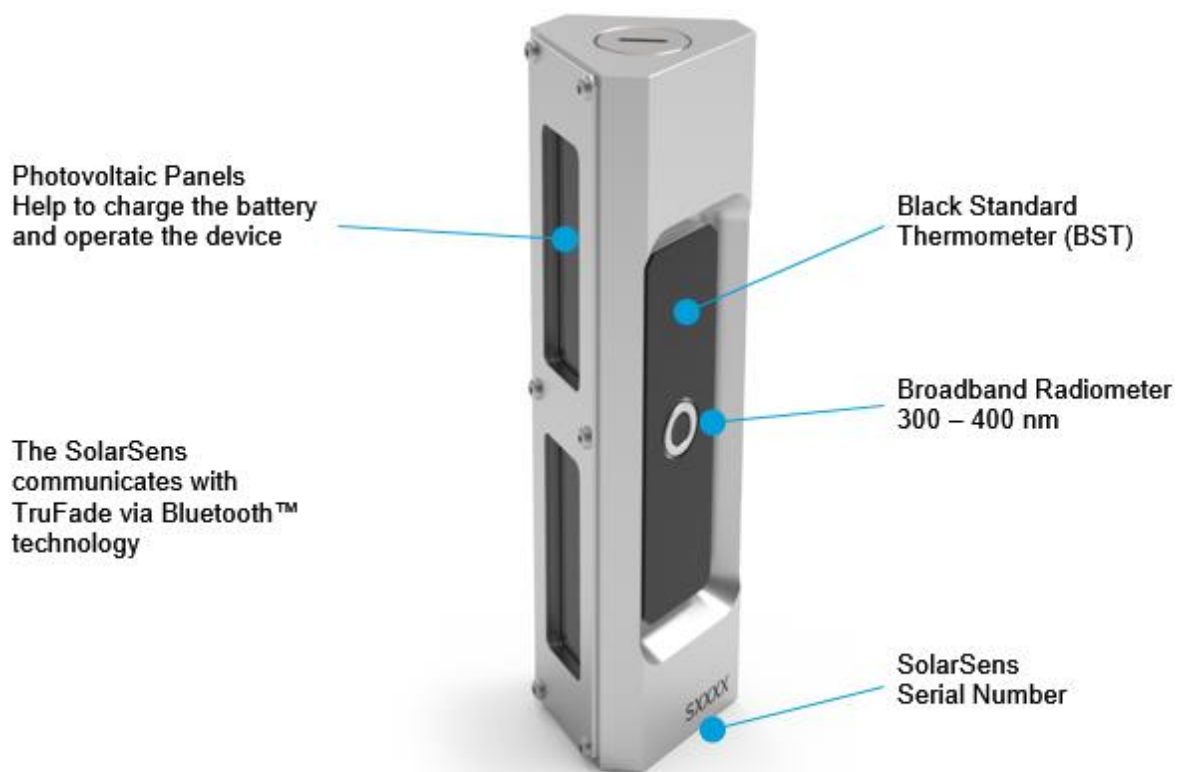

### 794-103 – SolarSens for TruFade 1800

# Weathering Blue Wool Sample Holder

When Blue Wool References are used in a weathering test, contrary to the expected, they are not exposed to the effects of the water spray but are protected in a special Weathering Blue Wool Sample Holder.

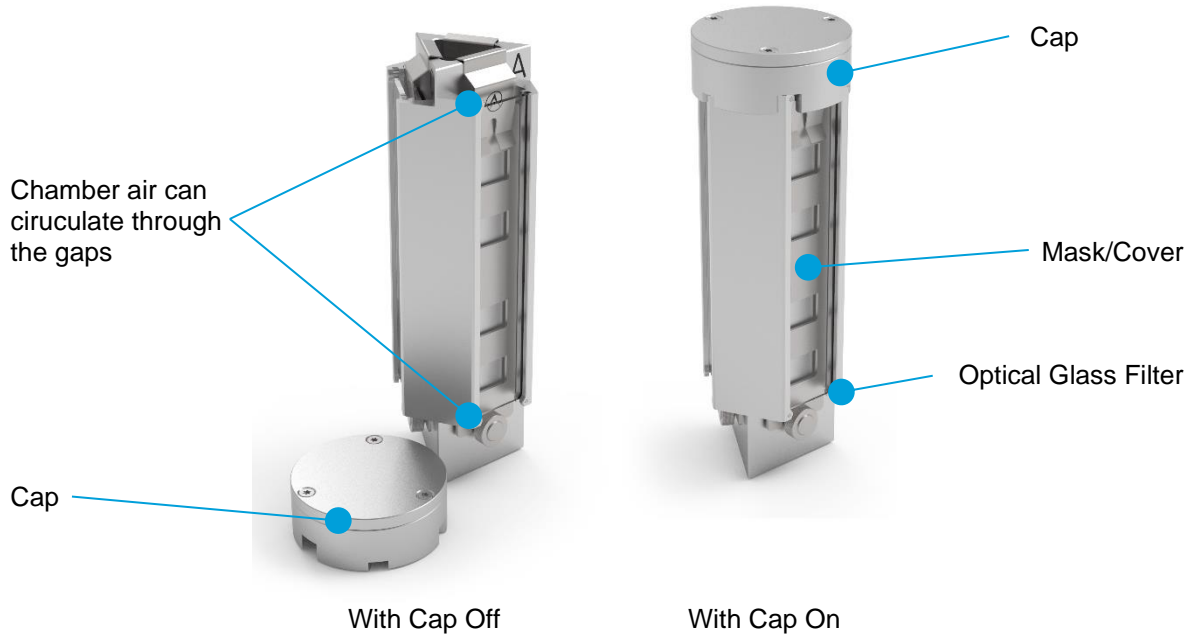

**794-102 Weathering Blue Wool Sample Holder**

When conducting weathering tests with water spray, the Cap must always be in place to prevent ingress of water from above. The Cap is loose fitting to allow the chamber air to circulate into the Weathering Blue Wool Sample Holder.

# INSTALLATION

## Operating Environment

To achieve the widest range of chamber performance, we recommend ambient conditions of 20°C and 65% RH.

It is therefore recommended that TruFade is installed in a standard conditioned environment suitable for textile testing.

TruFade will operate satisfactorily within the following environmental limits:

- Recommended Ambient Temperature Range 16 - 24°C
- Recommended Ambient Humidity Range 30 - 70%RH (non-condensing)

The TruFade should be installed at least 2 metres away from the direct impact of any heating devices such as hot air heater or blower and/or air conditioning system to ensure the smooth and consistent running of the instrument at all times.

## Installation Requirements

- Footprint** The TruFade 1800 has a footprint of 760 mm width x 760 mm depth. Please note that sufficient free space must be allowed at the front of the TruFade to allow the chamber door to open to inset or remove specimen holders and to open the large front door to access the Water Tank and Air Filters.
- Height** The TruFade 1800 is 1812 mm in height. Please note that the user must allow sufficient free height about the TruFade to replace the Xenon Lamp.

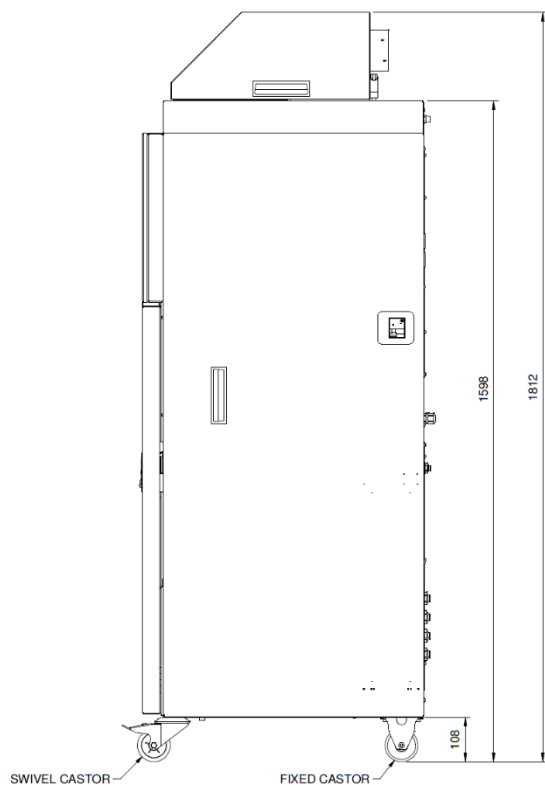

Height: 1812 mm

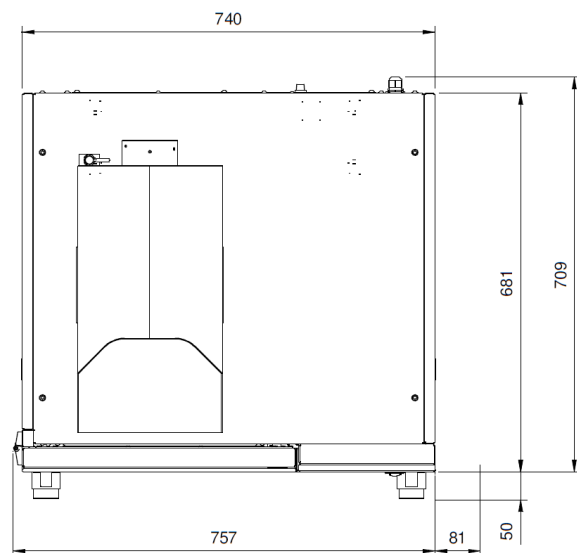

Footprint: 760 mm x 760 mm

## Electrical Connection

- The unit is designed for a single-phase mains supply of nominally 230V 50/60 Hz with a maximum power consumption of 3.25kW. Where 110V is the nominal supply voltage, TruFade must be connected across two phases to achieve 220V.  
**One single-phase 110V supply is not suitable.**
- Attach the mains inlet cable to a fused isolator rated at 16A. A plug and socket can be used in addition to the fused isolator if required.  
**It is advisable to discuss these requirements with your works electrician.**
- Prior to installation, check the serial number plate on the rear of the unit to confirm the voltage, frequency and phase are in accordance with your local requirements.



## Heat Output

- The xenon lamp is air-cooled and the heat generated is exhausted at the rear of the TruFade.
- The warm air is discharged at a rate of 600 m<sup>3</sup>/h at approximately 50°C.
- The discharge does not contain ozone.
- The exhaust should be vented outside the testing room with 100 mm internal diameter hose to reduce the work load on the laboratory air conditioning unit.
- A 1.5m length of flexible hose is available as an optional extra – stock code **327-290**.
- Where an exhaust hose of greater than 1.5 m is required, the heat discharge must be fan assisted.

## Water Supply and Drains

- A continuous supply of distilled water or water complying with ISO 3696, minimum Grade 3 is required. For example, ISO 3696 Grade 3, 2 & 1 are all acceptable. It may be piped directly into the TruFade via the water inlet highlighted by the blue circle above, or through the internal water reservoir.



Incoming water connection: 8 mm

- Water consumption is dependent on ambient humidity and the desired effective humidity. The maximum water consumption is 1.6 litres/hour when using humidification only. Under normal laboratory conditions, consumption is approximately 200 ml/hour to achieve ISO 105-B02 normal humidity conditions.
- The TruFade has 2 overflow outlets highlighted by the blue circle on the image above these are for the internal water reservoir and the humidity tank. These require connection to a drain. If a nominal 32mm (1¼") diameter free drain is not available a container can be used, but this will need emptying periodically.
- The internal water reservoir can hold up to 39 litres (10 US gallons) of deionised water. This can be accessed and filled by following the diagrams below. The water overflow will operate at 40 litres.

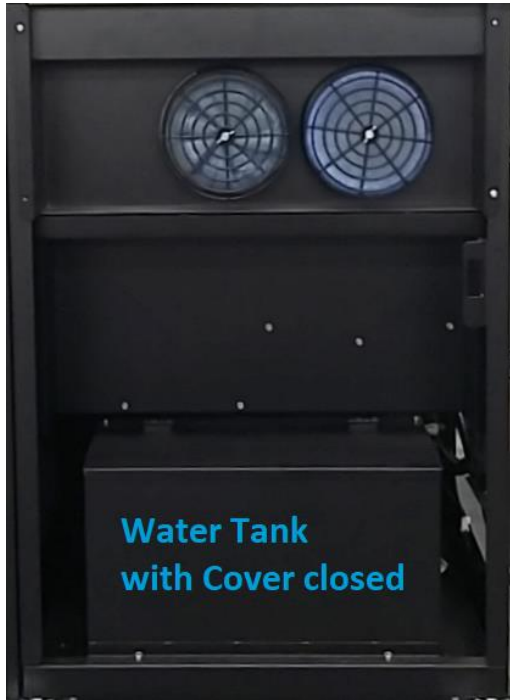

Open the large lower door on the front of the TruFade.

This will allow access to the internal water tank (reservoir).

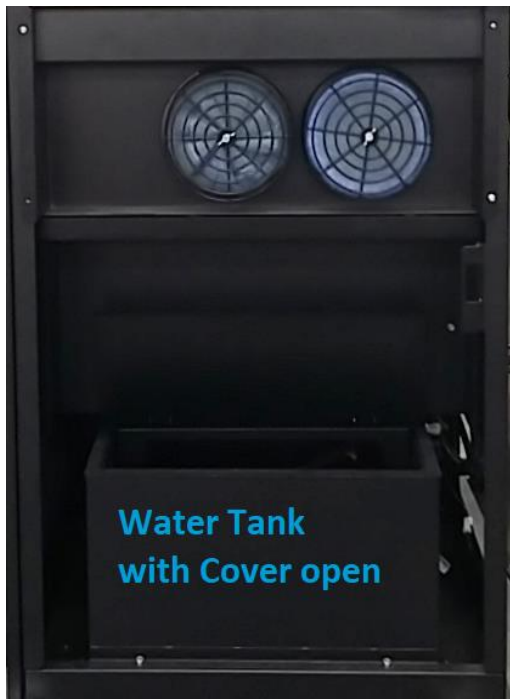

Lift the Cover of the Water Tank to view the level or manually fill with grade 3 deionised water.



View inside the Water Tank.

Red article is the Ball Cock Float.



- The water reservoir inside the unit feeds water in to the humidity tank in the same way as a direct water feed would. If the water level is low in the water reservoir, the TruFade will display a warning.
- Should there be a failure in the water supply either direct or from the internal reservoir, the humidity tank will maintain running. Should the humidity tank run low, the test will stop and a warning will be displayed. Once the water supply has been restored, the test can be resumed by touching the 'Start' button.



If using deionised water from a gravity feed system, the feed outlet should be greater than 1metre from floor level, that is, above the water inlet connection on the back of TruFade.

TruFade utilises common push-fit connections for which 5 metres of  $\varnothing$  8mm (water supply) and 5m of  $\varnothing$ 12mm (water drain) tube are supplied.

- Should you require water purification equipment we can offer details of a suitable package, which satisfies the requirements of TruFade.



There are four (4) connections  $\varnothing$ 12mm for water drains.

ALL 4 connections should be connected, via the pipe supplied, to the drain.

## Water Consumption

The Water Tank has a maximum capacity of 39 litres.

Typical water consumptions are:

ISO 105-B02 Method 1	0.2 litres/hour	(humidification only)
ISO 105-B04 Method 1	0.5 litres/hour	(2 minutes of water spray per hour)
Maximum consumption	1.6 litres/hour	(system maximum)

## ISO 3696 - Requirements for Grade 3 Water

Grade 3 Water is suitable for most laboratory wet chemistry work and preparation of reagent solutions and should, for example, be produced by single distillation, by deionization, or by reverse osmosis. Unless otherwise specified, it should be used for ordinary analytical work.

**Note:** It is assumed that the initial feed stock water is potable (drinking quality) and reasonably pure. If it is heavily contaminated in any respect, some pre-treatment may be necessary.

Parameter	Grade 3
pH value at 25°C inclusive range	5.0 to 7.5
Electrical conductivity mS/m at 25°C, max.	0.5
Oxidisable matter, Oxygen (O) content mg/l, max.	0.4
Residue after evaporation on heating at 110°C mg/kg, max.	2

## UNPACKING

- See Technical information for dimensions and weight.
- Read all of these instructions before beginning to unpack the instrument.
- Before unpacking, transport the box to the room where the instrument is to be located.
- Sufficient free space must be allowed at the front of the TruFade to allow the chamber door to open to inset or remove specimen holders.
- The user must allow sufficient free height about the TruFade to replace the Xenon Lamp.

Read all of these instructions before beginning to unpack the instrument.  
Before unpacking, transport the box to the room where the instrument is to be located.



Only one side of the box needs to be removed when unpacking the TruFade.

The removable side is the only one with screws, the other sides are nailed.

Using power tools or a screwdriver, remove the screws down both sides of the pallet.



With the screws removed, the side should come off freely.

After carefully removing the side, remove the foam packing behind it to leave the instrument in view.



Down the side of the instrument is an access ramp.

Remove this ramp carefully.

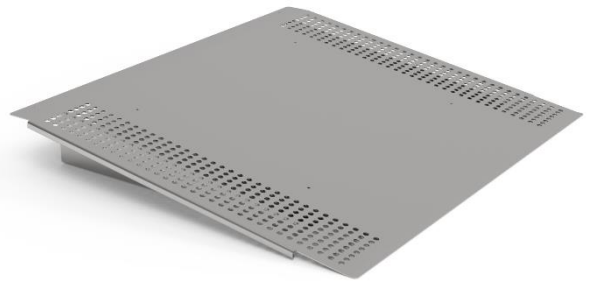

Position the ramp on the front of the box so that the instrument can be reached with a pallet truck.



Secure the ramp in position with power tools or a screwdriver as shown here.



Use a pallet truck to lift the TruFade down the ramp.

This should be done with 2 people as the machine is very heavy and can topple.

Remove the plastic wrapping, being careful not to damage the instrument underneath.



With the machine unwrapped, the transit frames will need to be removed.

The frames are bolted through the base and secured with nuts on the underside.

To access the bolts, simply open the TruFade door and they are visible down the sides of tank (shown here in red).



Lift the instrument off the floor with the pallet truck once more; as the frames protrude lower than the castors.

The nuts and bolts are M12 and so require a 10mm hex key and a 19mm spanner respectively.

Due to limited space down the side of the tank, a ratchet is recommended to make the process easier.

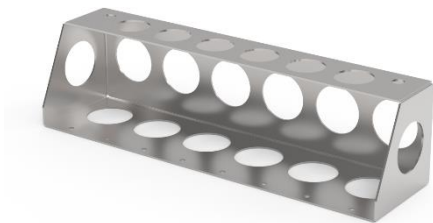



Place the feet of the air outlet into the slots on the top of the machine



Slide the air outlet in the slot to secure it in place.

# TECHNICAL SPECIFICATION

**LIGHT SOURCE** 2200W Air-cooled ozone free xenon lamp  
Adjustable from 1400W to 2200W  
Cooling: Centrifugal blowers 600 m<sup>3</sup>/h

**IRRADIANCE** SolarSens UV radiometer and BST  
  
300-400nm Broadband Sensor: 25.0 to 200.0 W/m<sup>2</sup>  
Automatic selection via test parameters  
TruFade Operating range 40 - 50W/m<sup>2</sup>  
  
Optical filter arrangement utilizing infrared absorbing glass.

**STANDARDS** The following standards are pre-programmed:

AATCC 16.3 – 2017 Option 3  
AATCC Test Method 169 – 2017 Option 4  
ISO 105 B02: 2014 Cycle A1  
ISO 105 B02: 2014 Cycle A3  
ISO 105 B02: 2014 Cycle B  
ISO 105-B04: 1997  
ISO 12040: 1997 (2003)  
GB/T 8427 – 2008  
M&S C9 – 2015  
M&S C9A – 2015  
Next TM1  
DS-288 version C

**TEST CHAMBER ENVIRONMENT** Fully automatic setting and control of all test parameters, including:  
Temperature and humidity, turntable speed and irradiance, with continuous monitoring of test conditions.

Automatic re-start after power failure and lamp cool-down period at end of test (default setting is off – no re-start).

**CHAMBER TEMPERATURE** Cooling:  
Variable speed waterproof centrifugal fans  
Variable position air-vane to re-circulate air in chamber to stabilize conditions.

Measurement:  
Chamber Temperature Sensor 0 to 100°C  
Readability:0.1°C Accuracy: ±0.4°C.  
Interchangeable sensor.  
TruFade Operating range. Ambient - 70°C

Black Standard Thermometer (BST) 0 to 100°C.  
Readability: 0.1°C.  
TruFade Operating range. Ambient - 70°C

## CHAMBER HUMIDITY

Humidification:  
3 x Ultrasonic transducers, Oscillating @1.6MHz.  
Mist Output: 0 to 1425 ml/h (maximum).

Measurement:  
Chamber Relative Humidity Sensor.  
0 to 100 %RH  $\pm$  1.5 %RH.  
Readability 0.1 %RH Accuracy:  $\pm$  1.5 %RH.  
Interchangeable sensor.  
TruFade Operating range. Ambient – 55 %RH

Water consumption: 1.6 litres per hour (max).

## TURNTABLE (CAROUSEL)

9 position platen giving a maximum test area of 1640 cm<sup>2</sup>

Programmable 2 to 7 rpm in 1 rpm steps.  
Accuracy: Self tuning speed adjustment.

## SPECIMEN EXPOSURE

9 x Tri-Sided specimen holders (maximum 135 x 45 mm each side).  
Run continuously setting for manual checking.  
Automatically calculates irradiation dosage.

## SOFTWARE

User selectable languages:  
English, Chinese, French, German, Italian, Japanese, Korean, Spanish, Turkish, Vietnamese

## USB ports

USB1 Type A (Top)                      used to update TruFade firmware  
USB2 Type B                              used for debug / AutoTest data output

## SAFETY

Safety interlock on all access doors.  
Toughened NG4 Neutral density viewing window for safe viewing.  
Built-in self-diagnostics & warnings.

Machine complies CE Directives for machine safety, low voltage and EMC.

## ELECTRICAL RATING

3.5KW max. 230V  $\pm$ 15% 50-60Hz.  
Low electrical running cost due to high efficiency PFC lamp power supply.

## DIMENSIONS / WEIGHT

Width:760 mm Depth: 760 mm Height:1815 mm  
Shipping: 1120 x 930 x 2030 mm (crate dimensions)

Weight: 280 kg (dry weight - no water in tank)  
Shipping Weight: 425 kg

## AMBIENT CONDITIONS

The recommended operating environment is 20°C and 65%RH

## DIAGNOSTICS

Built-in service utilities for James Heal Service and Calibration engineers only



# EU Declaration of Conformity



## EU DECLARATION of CONFORMITY

This declaration is issued under the sole responsibility of the manufacturer.

We **James Heal**  
of **Richmond Works, Halifax, HX3 6EP, UK**

in accordance to the following directive(s):

2014/35/EU	The Low Voltage Directive
2014/30/EU	The Electromagnetic Compatibility Directive
2011/65/EU	The RoHS Directive

hereby declare that:

<i>Equipment:</i>	<b>TruFade</b>
<i>Models:</i>	<b>1800 Series</b>
<i>Description:</i>	<b>Light Fastness Tester</b>
<i>Serial Numbers:</i>	<b>1800/18/1000 &amp; subsequent</b>

is in conformity with the relevant Union harmonisation legislation, based on the conformity of the following documents:

*Applied Harmonised Standards:*

<i>Ref. No</i>	<i>Title</i>	<i>Edition/date</i>
EN 61010-1	Safety requirements for electrical equipment for measurement, control, and laboratory use. General requirements	2010+A1:2019
EN 61326-1	Electromagnetic Compatibility (EMC) equipment for measurement, control and laboratory use.	2013

I hereby declare that the above mentioned product is in conformity with the stated Standards.

Neil Pryke  
Innovation Director  
DATE: 1<sup>st</sup> Oct 2021

# UKCA Declaration of Conformity



## UKCA DECLARATION OF CONFORMITY

This declaration is issued under the sole responsibility of the manufacturer.

We **James Heal**  
of **Richmond Works, Halifax, HX3 6EP, UK**

hereby declare that:

*Equipment:* **TruFade**  
*Models:* **1800 Series**  
*Description:* **Light Fastness Tester**  
*Serial Numbers:* **1800/21/1048 & subsequent**

is in conformity with the relevant UK Statutory Instruments (and their amendments):

<b>2008 No. 1597</b>	<b>The Supply of Machinery (Safety) Regulations 2008</b>
<b>2016 No. 1091</b>	<b>The Electromagnetic Compatibility Regulations 2016</b>
<b>2012 No. 3032</b>	<b>The Restriction of the Use of Certain Hazardous Substances in Electrical &amp; Electronic Equipment Regulations 2012</b>

*Relevant designated standards:*

<i>Ref. No</i>	<i>Title</i>	<i>Edition/date</i>
<b>BS EN 61010-1</b>	<b>Safety requirements for electrical equipment for measurement, control, and laboratory use. General requirements</b>	<b>2010+A1:2019</b>
<b>BS EN 61326-1</b>	<b>Electromagnetic Compatibility (EMC) Electrical equipment for measurement, control and laboratory use.</b>	<b>2013</b>

AUTHORISED SIGNATORY

Neil Pryke  
Innovation Director  
DATE: 1<sup>st</sup> Nov 2021

Setting the Standard

James H. Heal & Co. Ltd. Halifax England

[www.james-heal.co.uk](http://www.james-heal.co.uk)

# External Dimensions

## TruFade 1800 External Dimensions

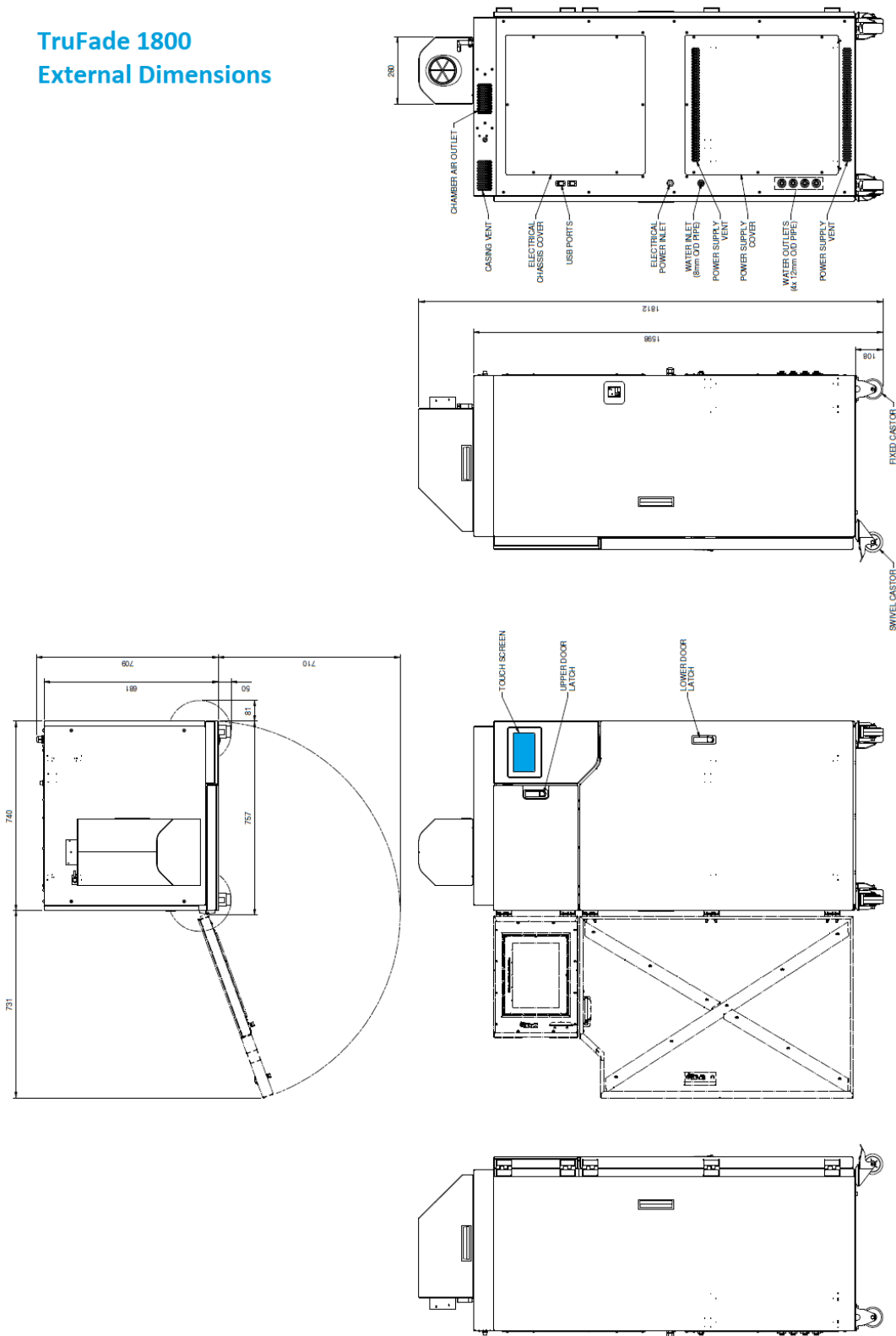

## REVISION HISTORY

Rev	Date	Originator	Details of revision
A	18/01/2019	PG	Original release
B	26/02/2019	PG	Added more detail to the "Updating TruFade Software" section (p.18) Added stock codes to specimen mask images (p.23-24)
C	22/07/2019	PG	Updated Unpacking instructions
D	13/08/2019	PG	Added information about installing xenon lamp
E	11/12/2019	PG	Operating Environment updated and moved to page 40
F	02/06/2020	SEW	Standards update
G	27/08/2020	SEW	Filters & standards updates
H	16/03/2021	SEW	Odometer instruction addition - pages 17-36
I	16/12/2021	GI	EU Declaration of Conformity updated UKCA Declaration of Conformity Page 74 added Contents Page updated Publication no. version corrected on cover page Footer updated with current year
J	01/11/2022	PL	Removed reference to expected lamp life
K	21/03/2023	LK	The name "Adidas" removed from the document